

**VELUX®**

# GXL/GXU

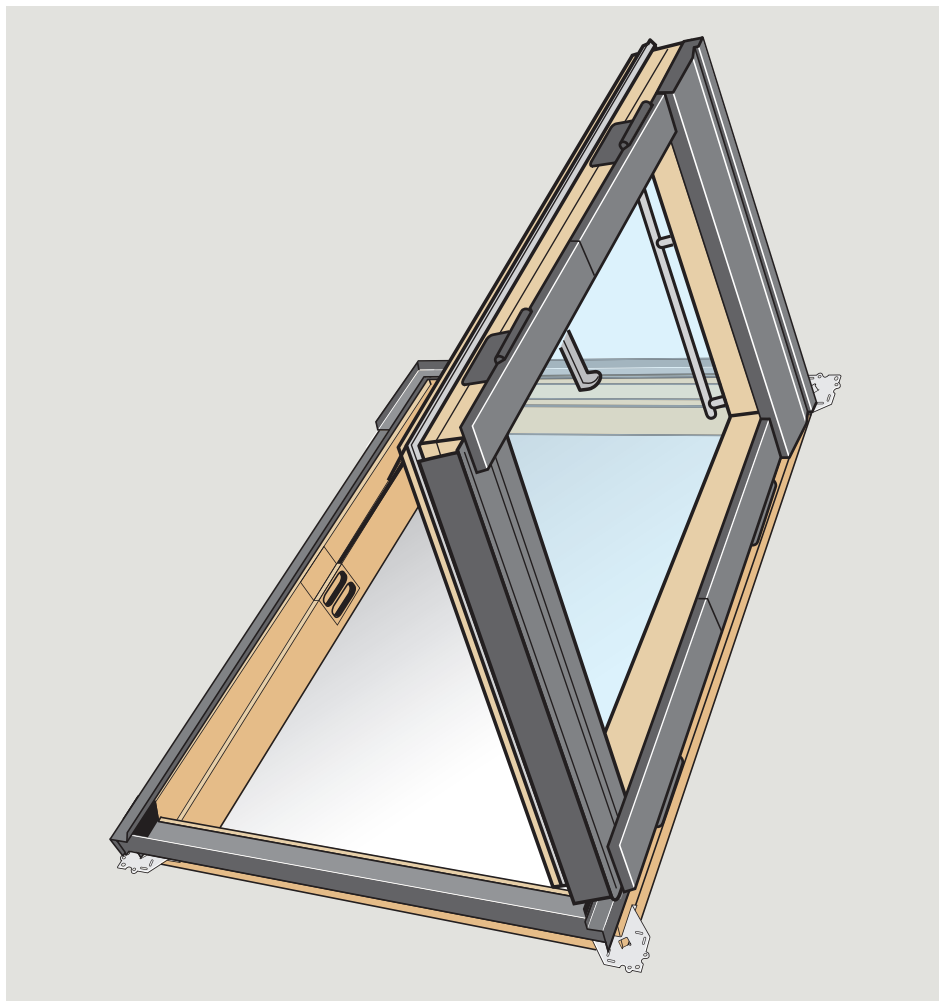

VAS 450757-2011-05

# GXL/GXU

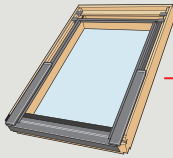

# E--

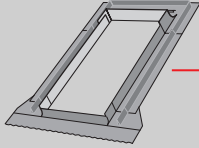

# BFX

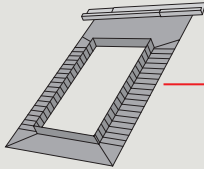

# BDX

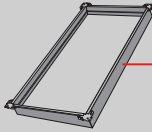

# BBX

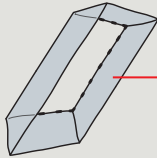

# LS-

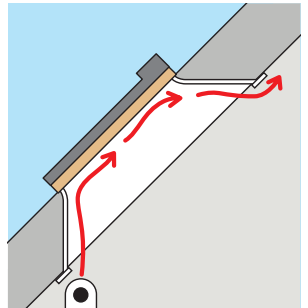
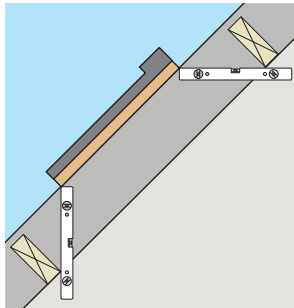
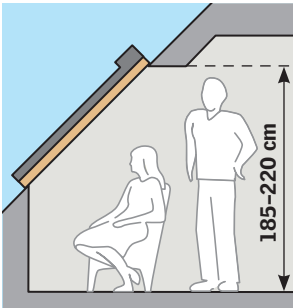
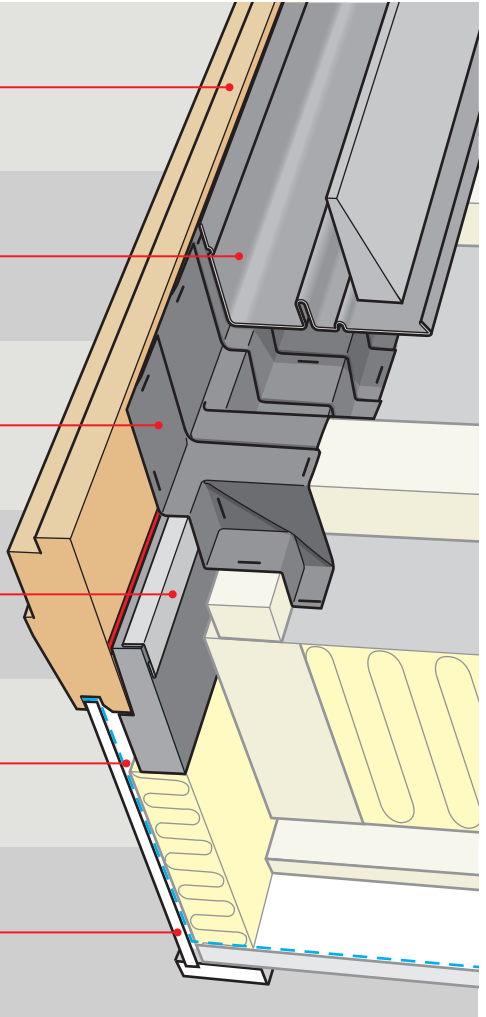
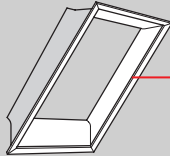

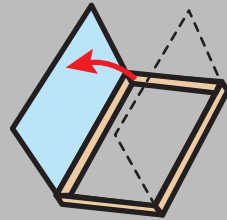
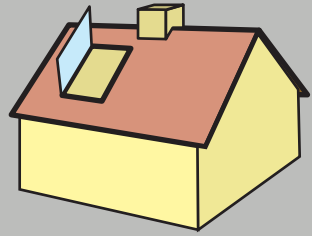
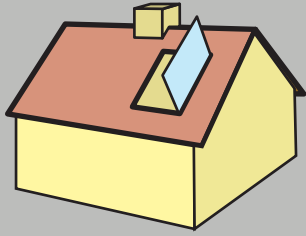

PAGES 20-23

1

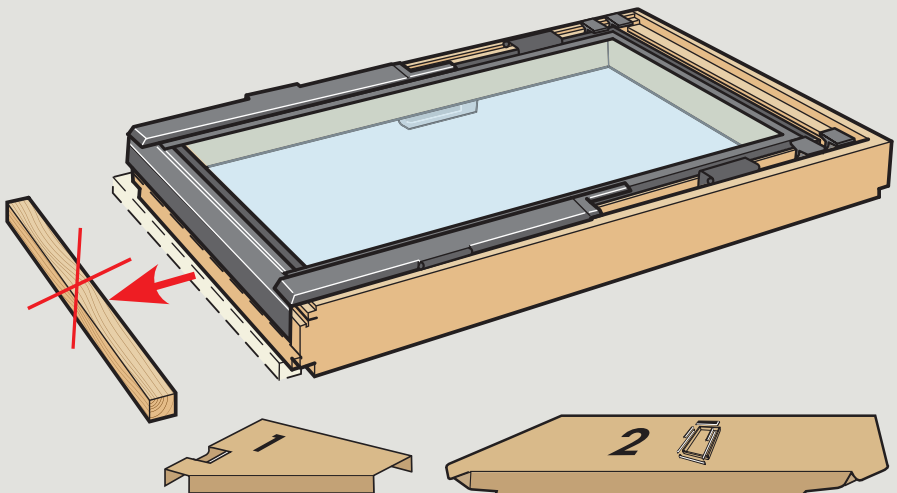



**EDS**  
**EDW**  
**EDZ**



**EDB**  
**EDE**  
**EDP**  
**ELX**  
**EW**

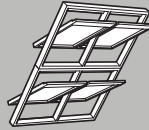

**EB-**  
**EK-**



**EF-**  
**GI-**  
**VF-**

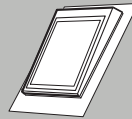

**EA-**  
**EU-**

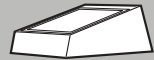

**ECX**



**2**

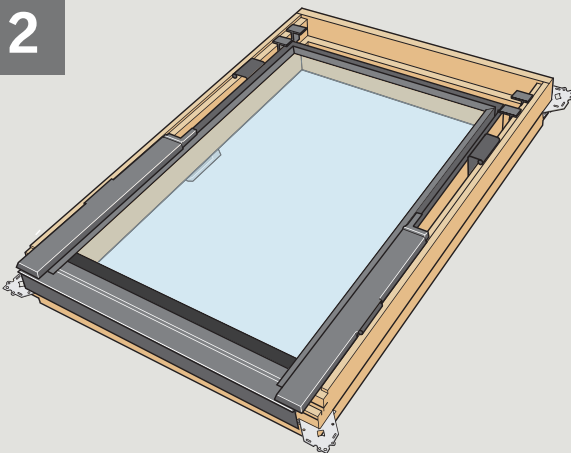

**30 mm**

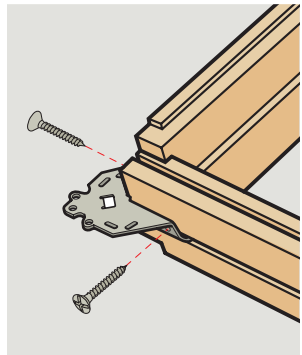

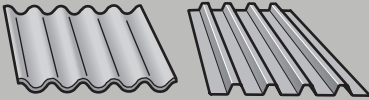
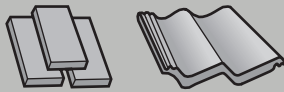

**EDW/EDZ**

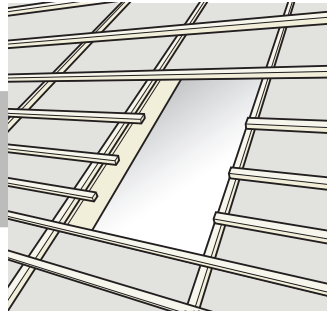

**3a**

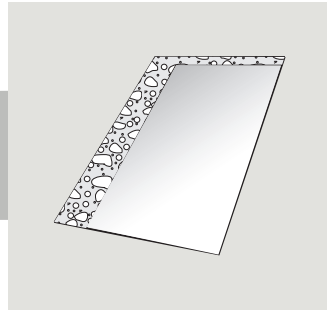

**3b**

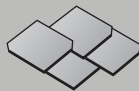
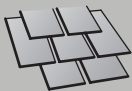

**EDS**

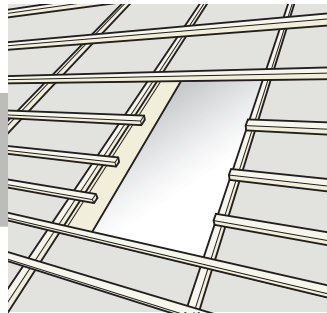

**3c**

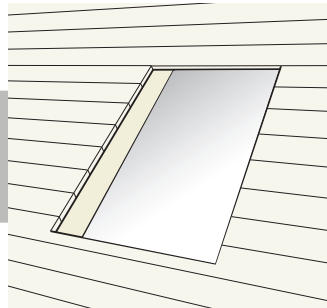

**3d**

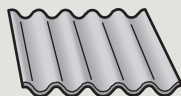
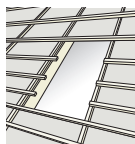

3a

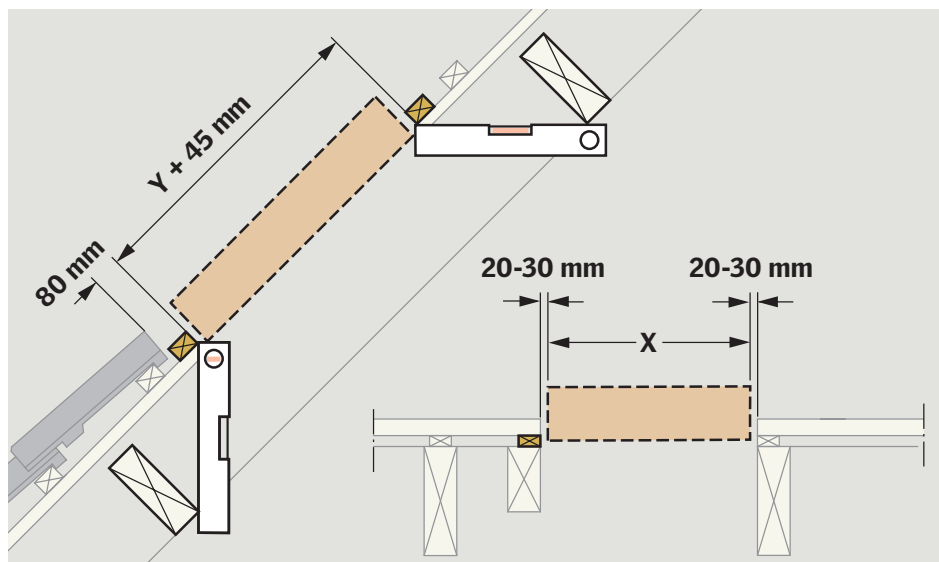
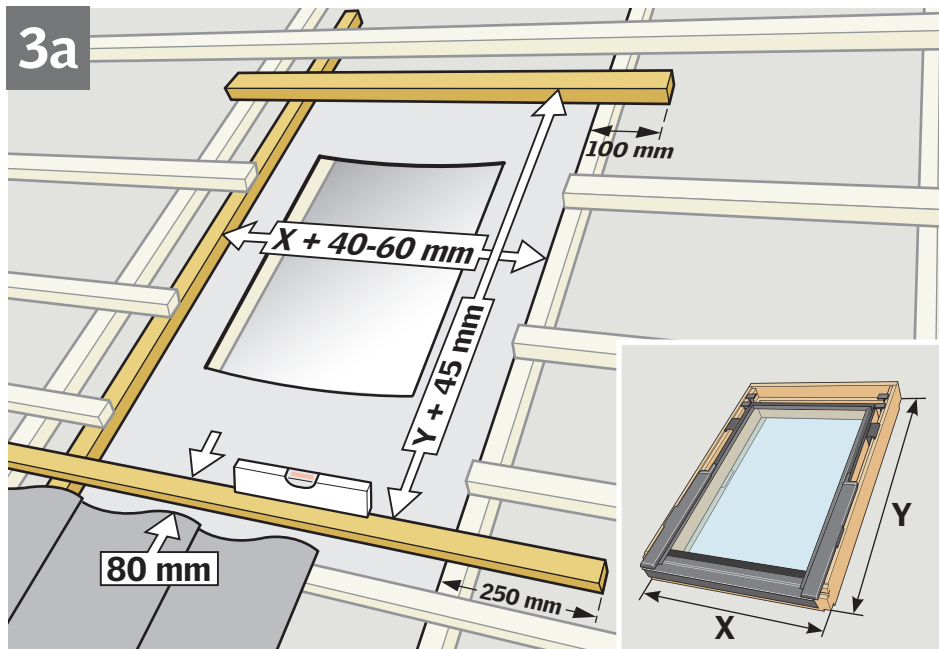

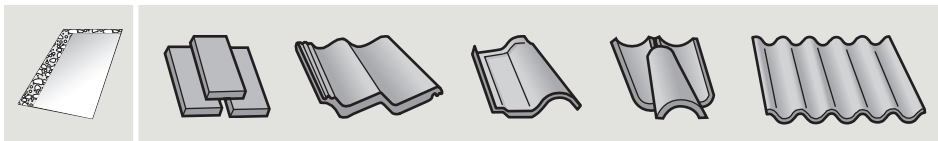

3b

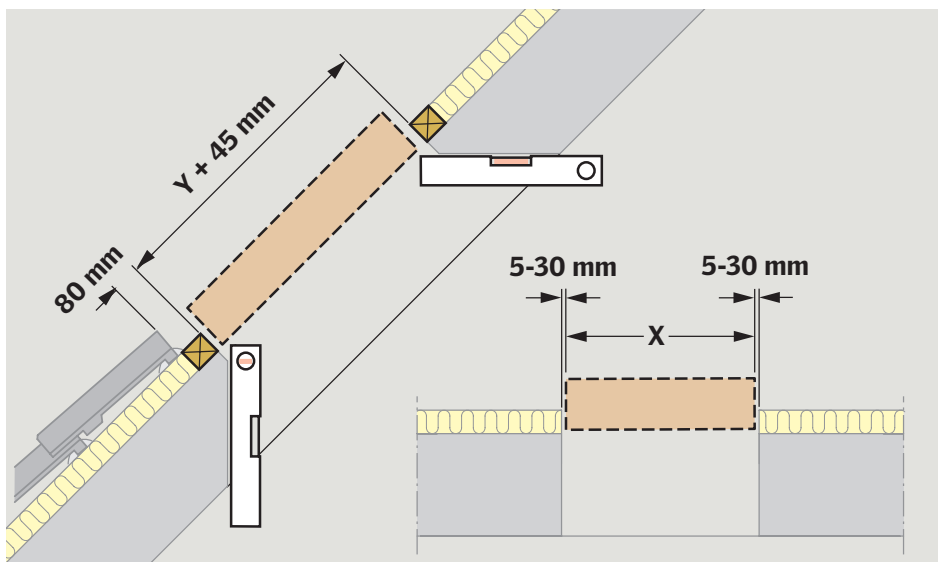
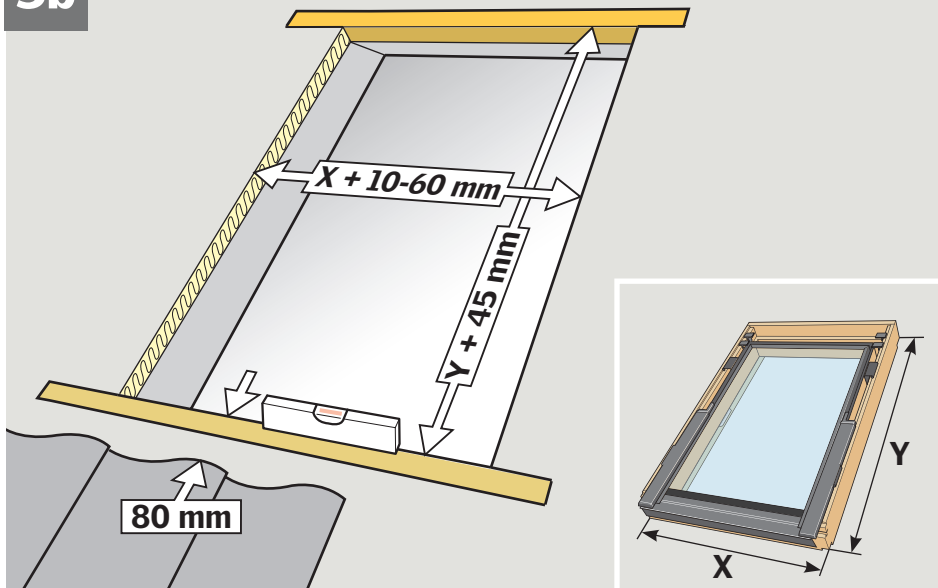

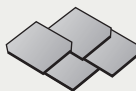
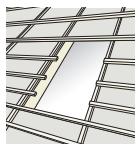

3c

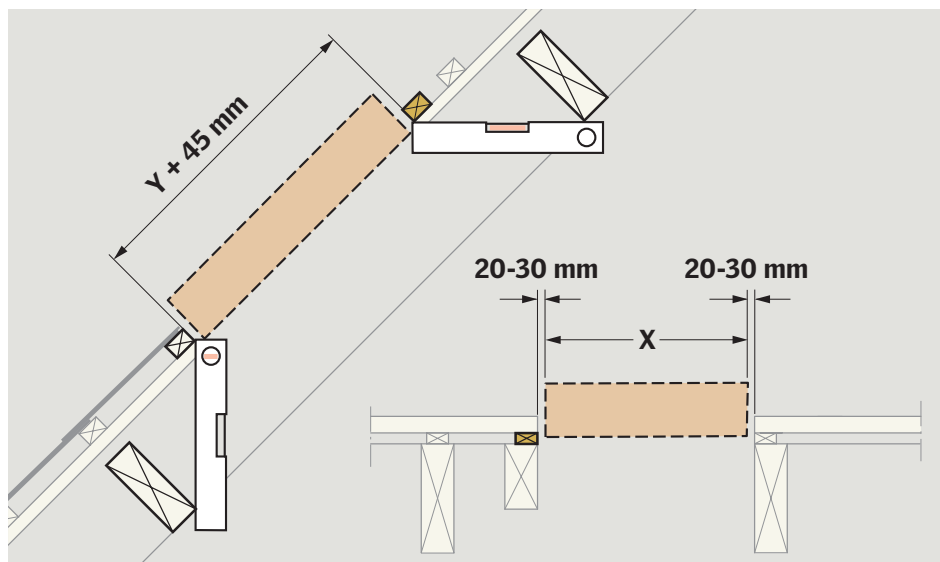
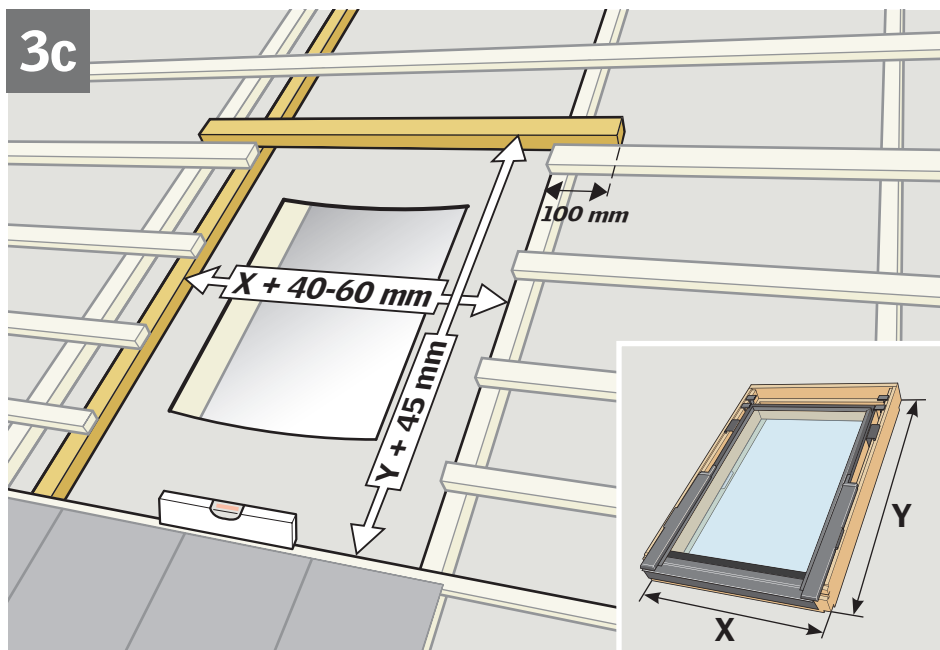



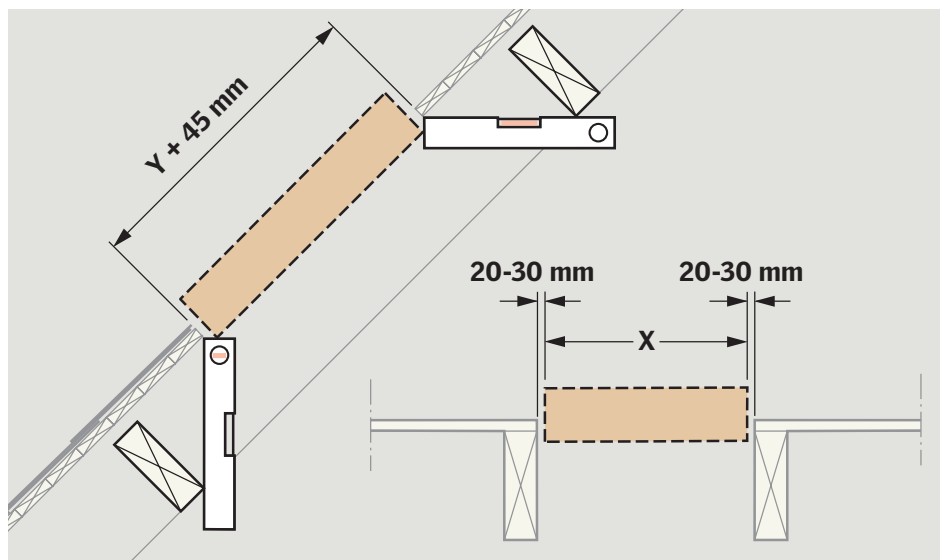
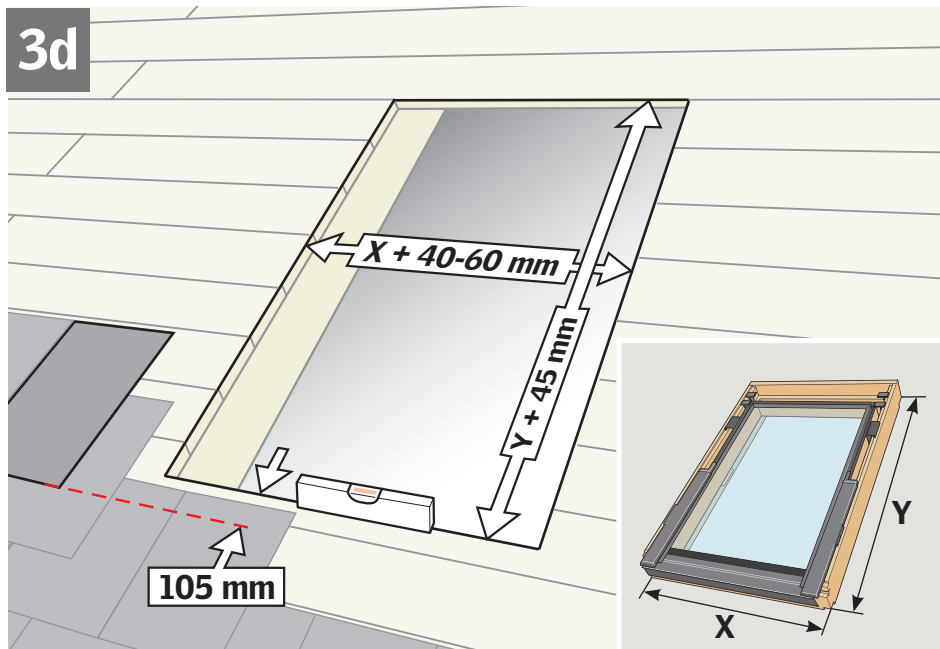
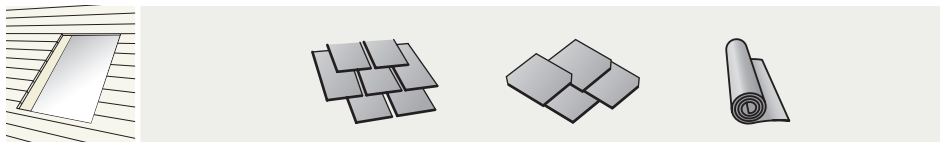

4

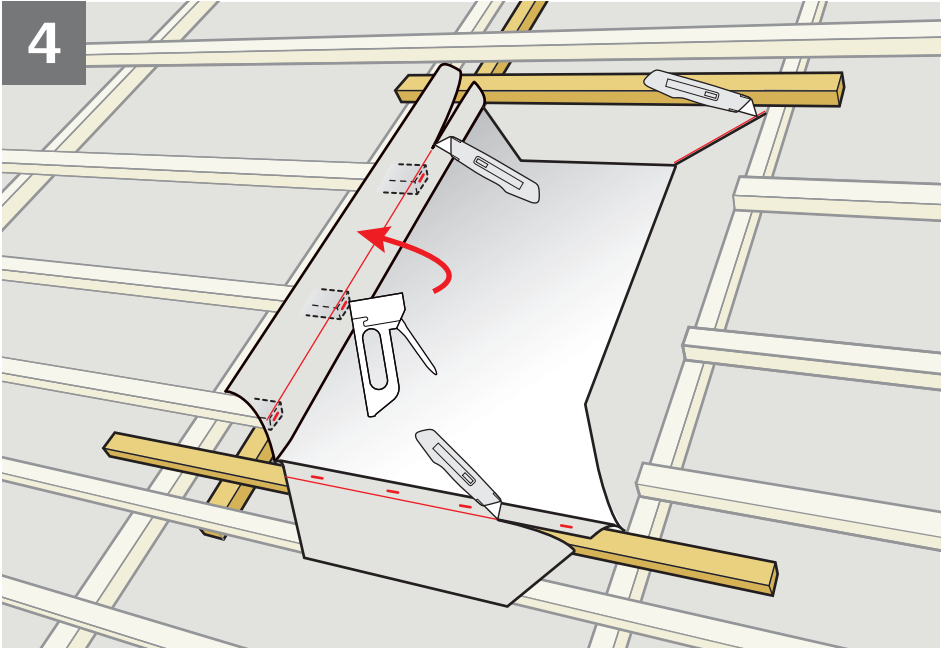

5

BDX

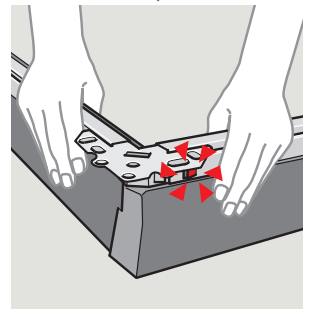
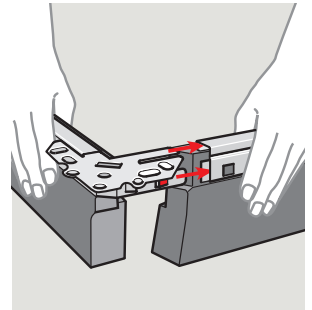
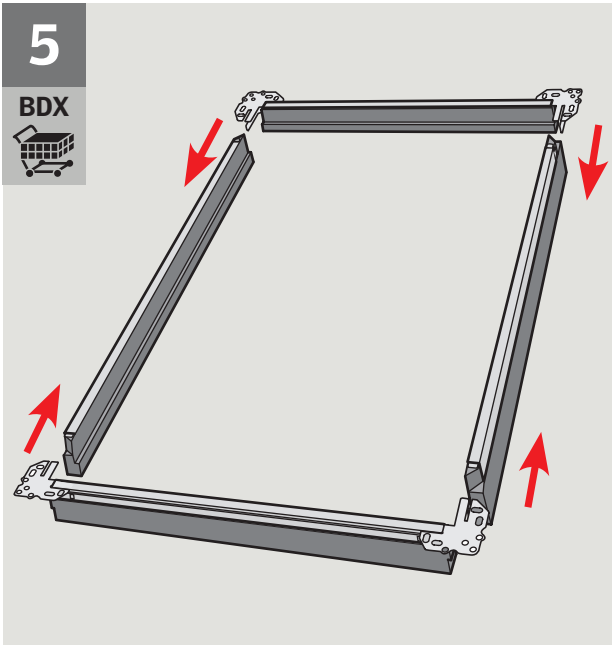

6

BDX

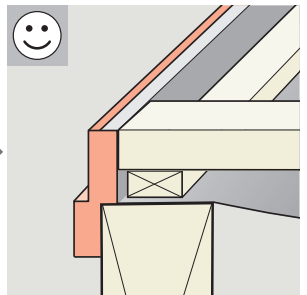
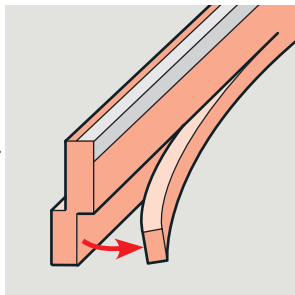
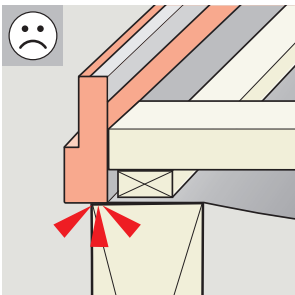
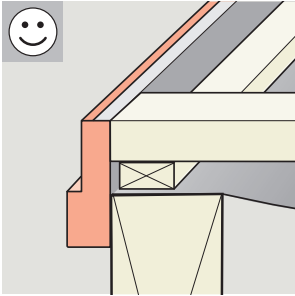
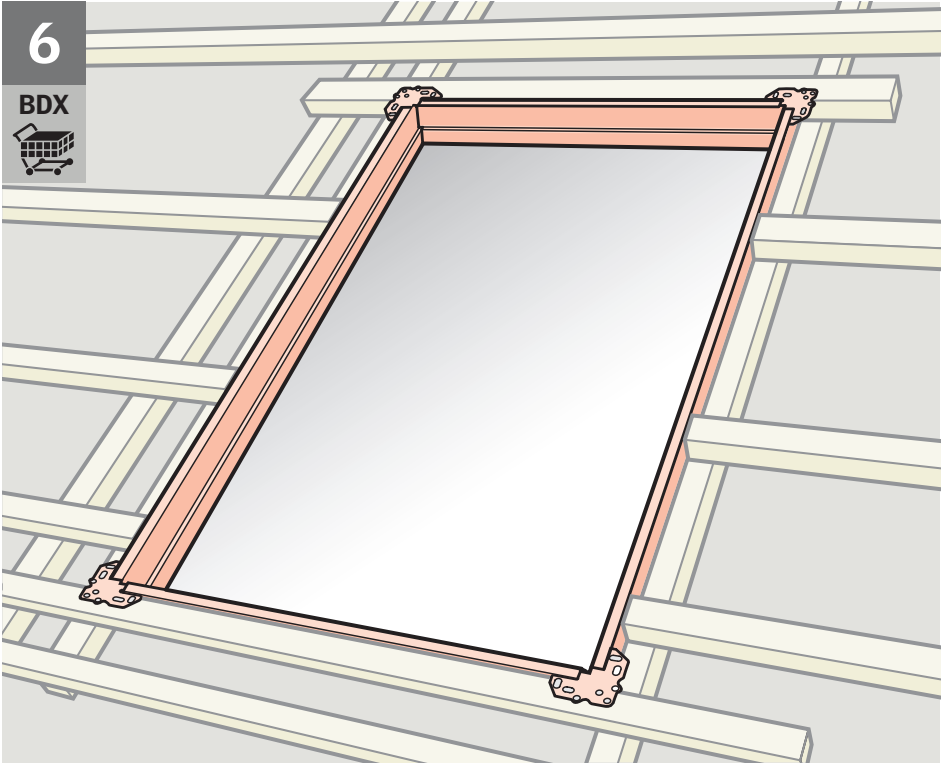

7

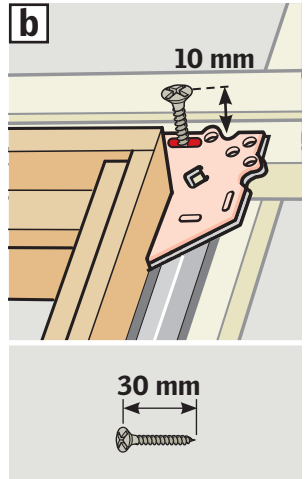
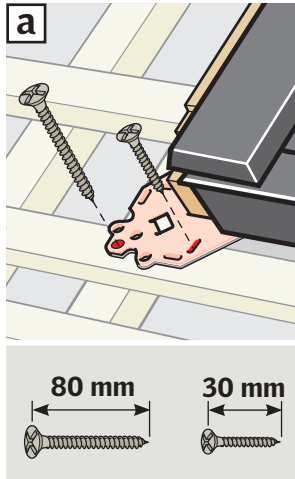
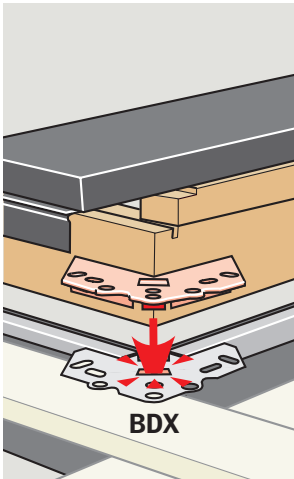
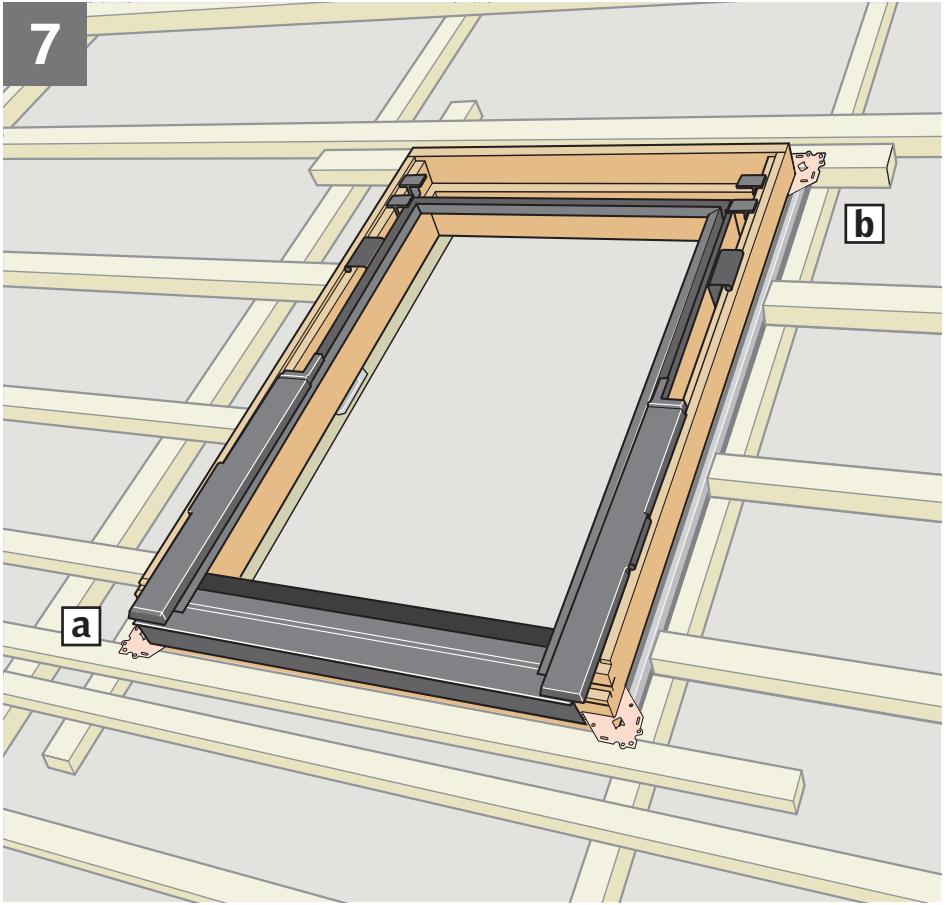

8

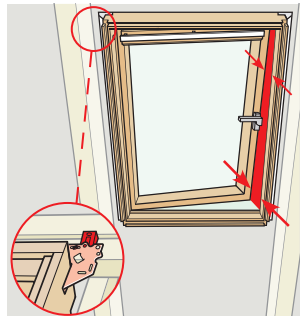
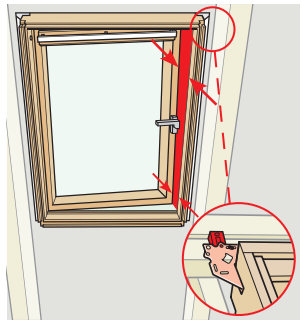
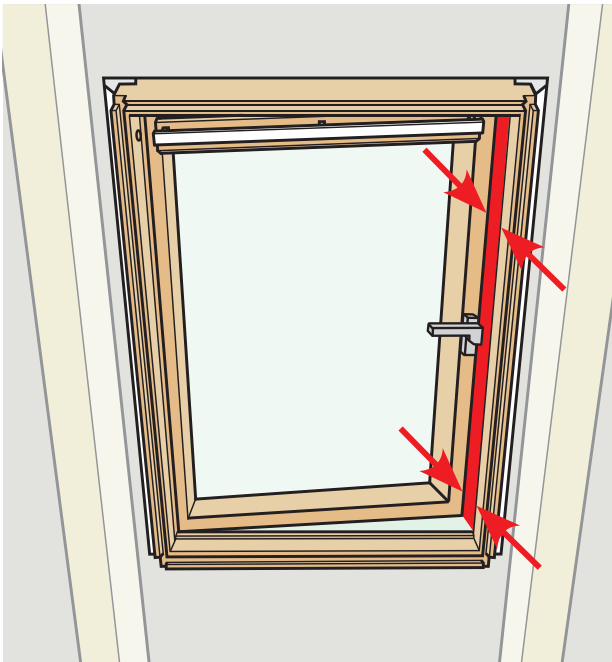
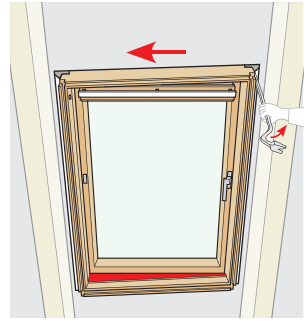
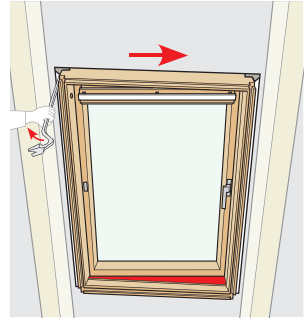
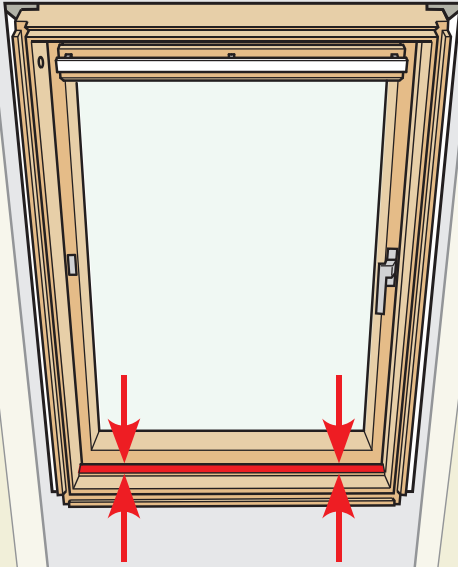

9

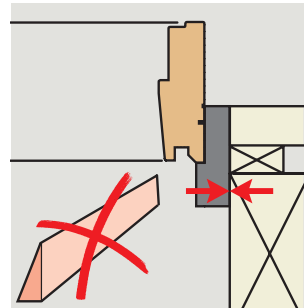
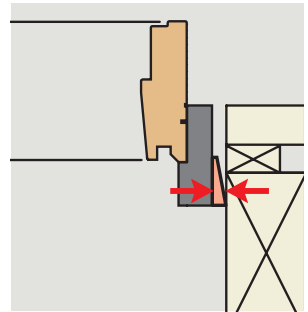
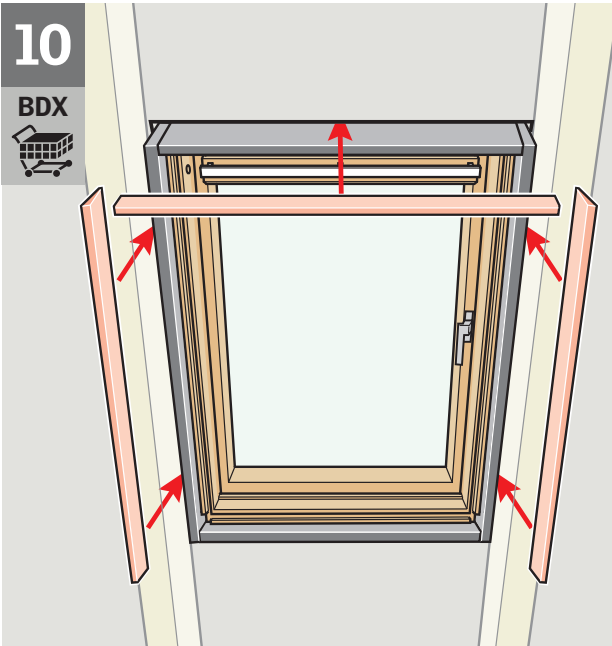
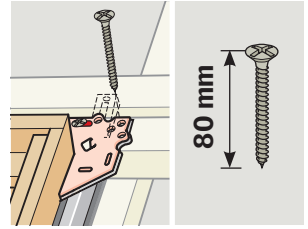
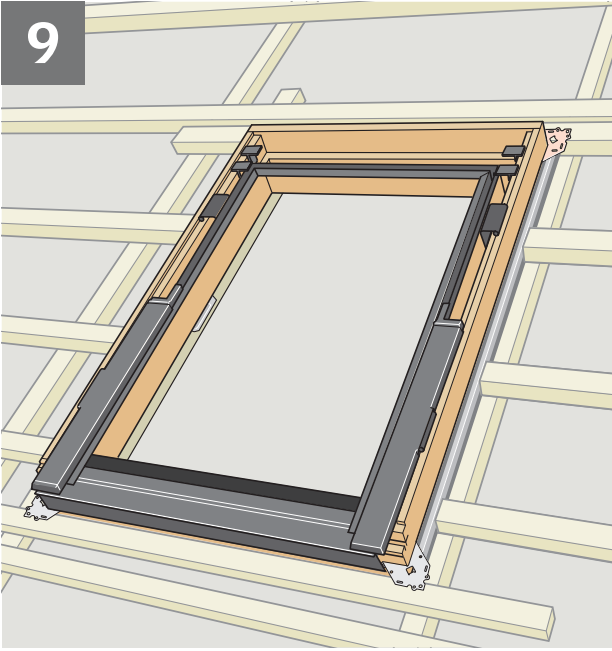

BFX

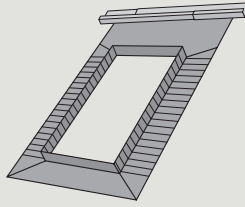

11

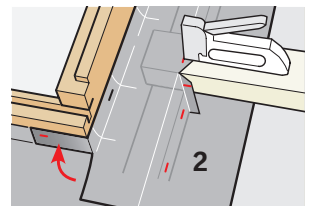
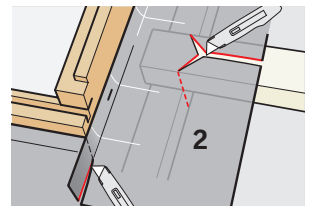
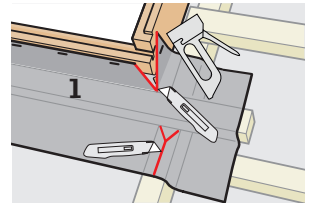
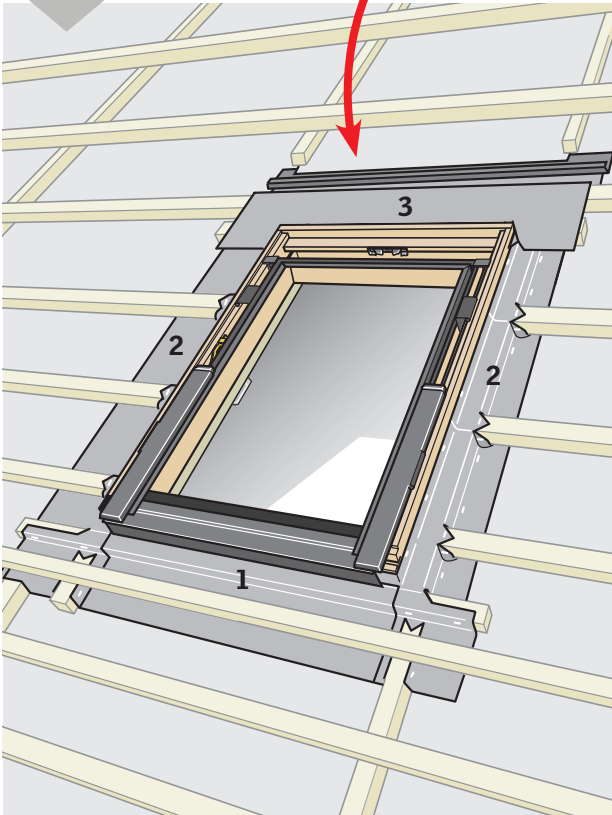
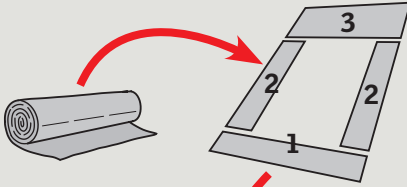

19

11

BFX



max 500 mm

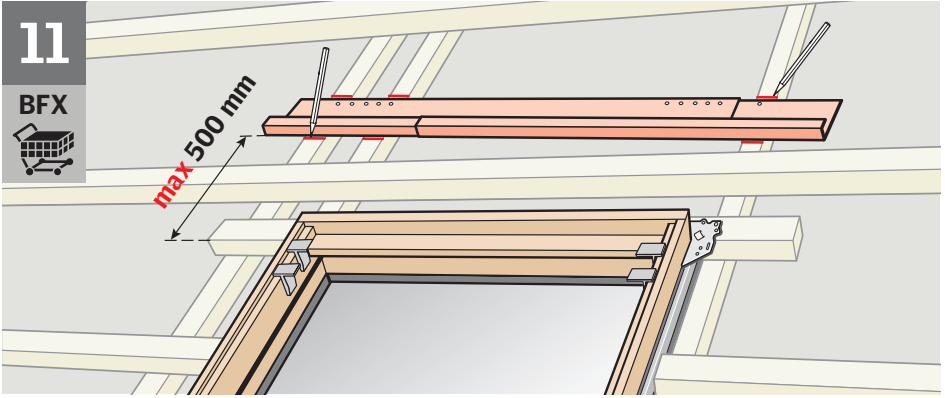

12

BFX

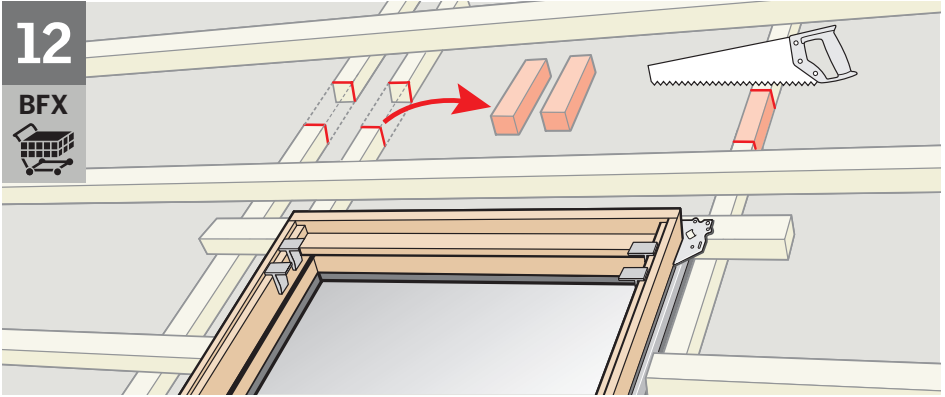

13

BFX

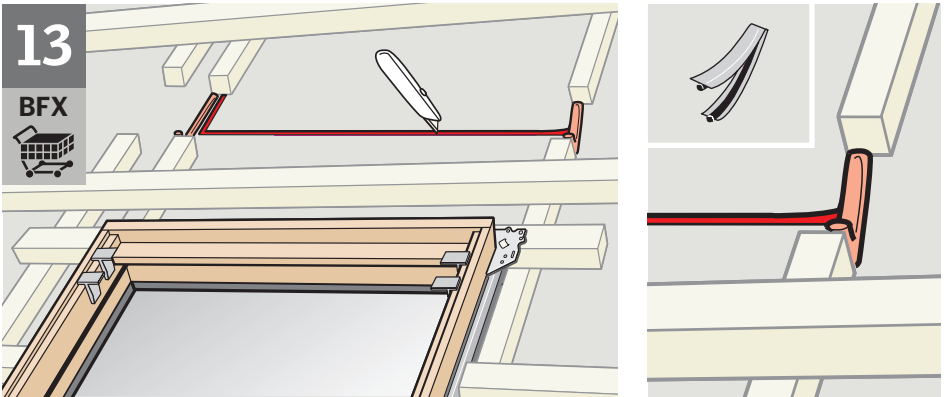



14

BFX

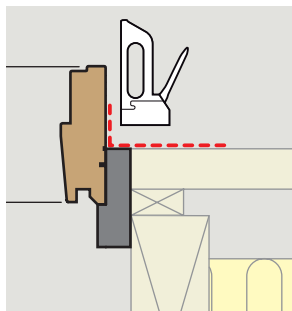
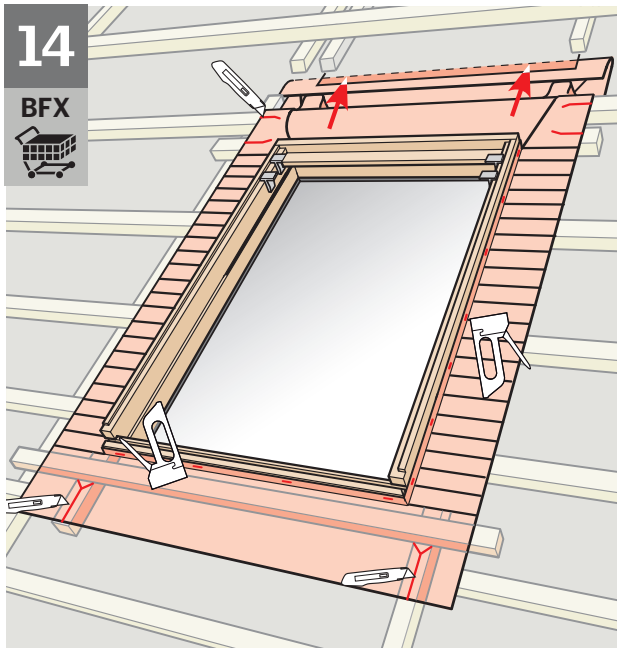

15

BFX

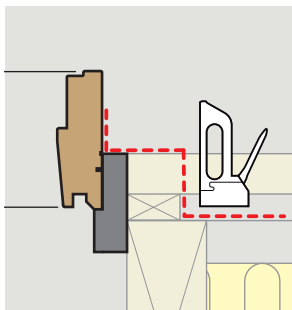
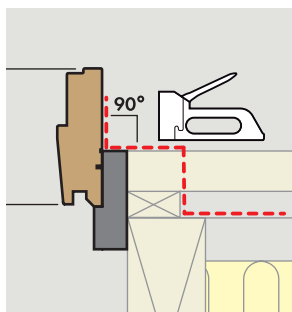
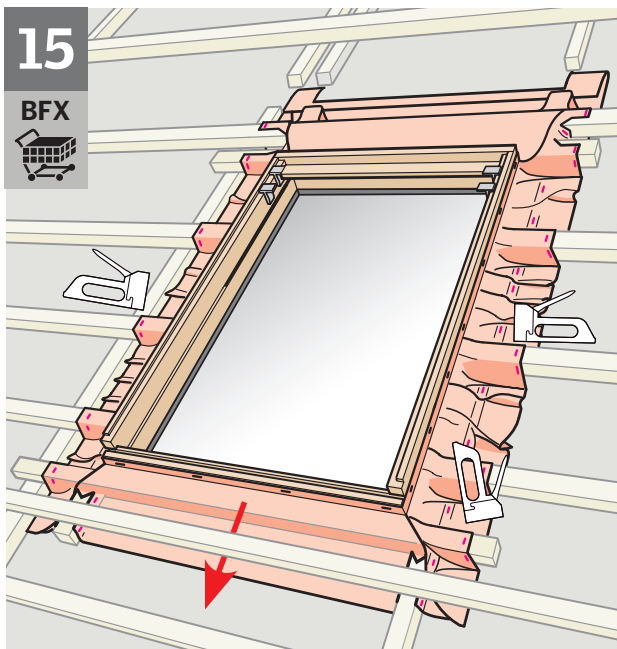

16

BDX

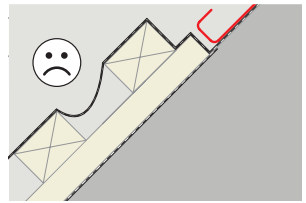
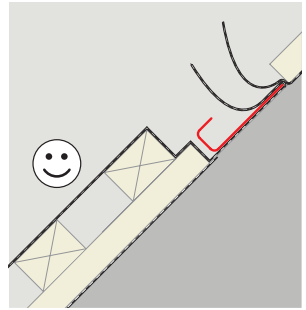
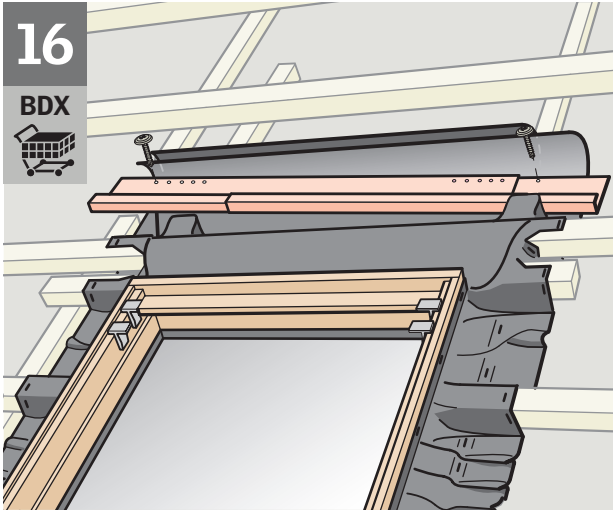

17

BDX

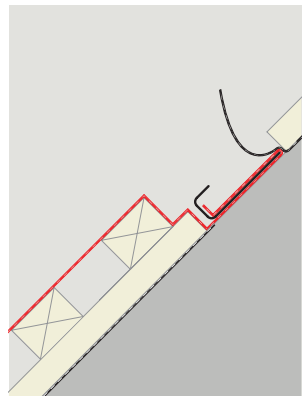
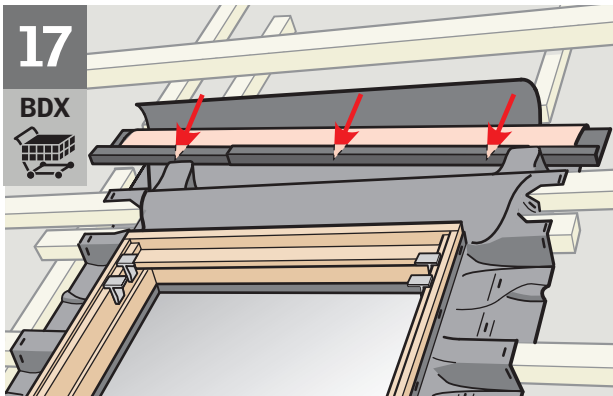

18

BDX

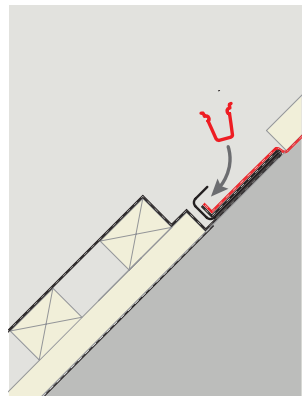
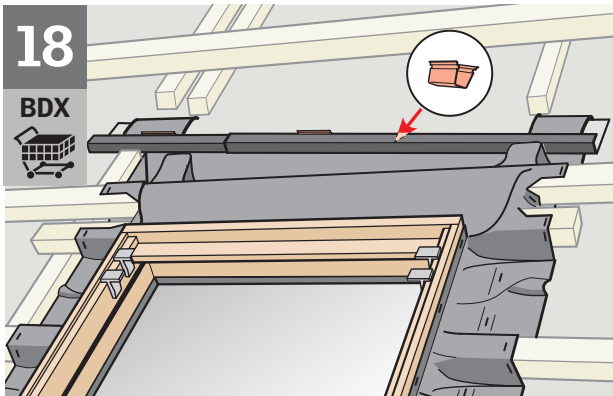

19

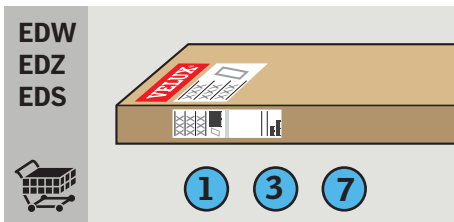
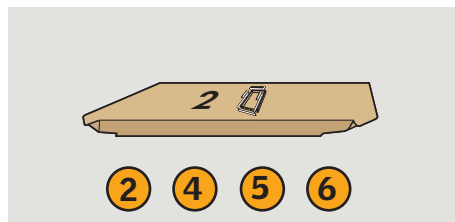
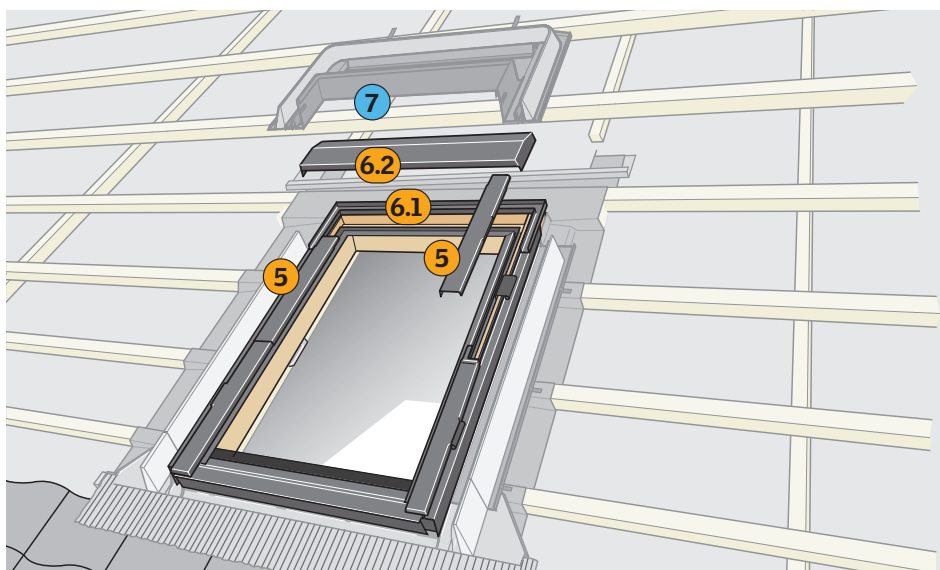
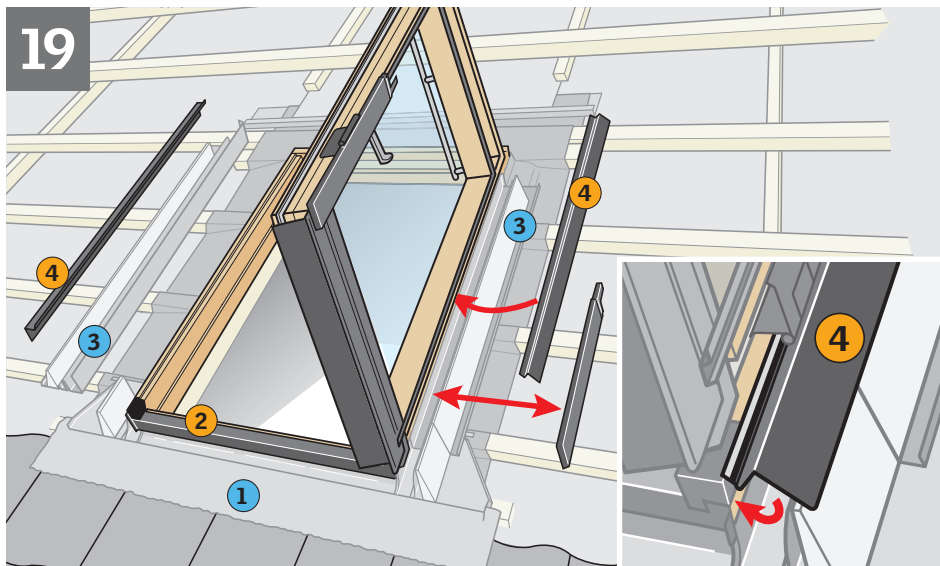

20

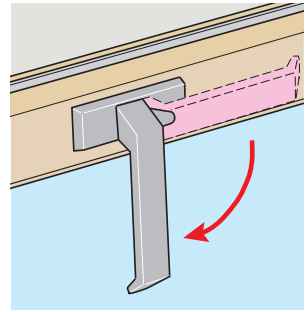
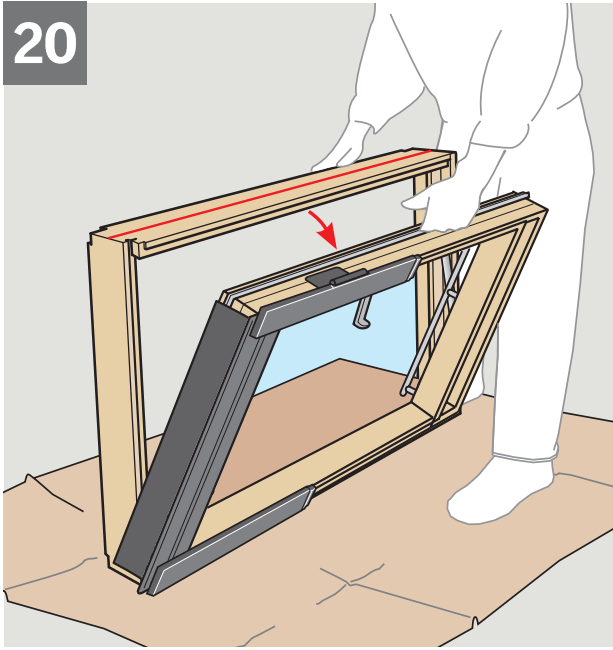

21

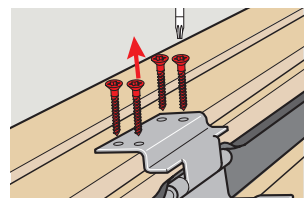
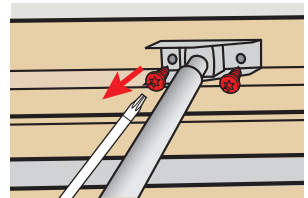
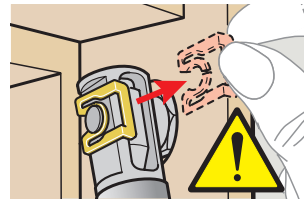
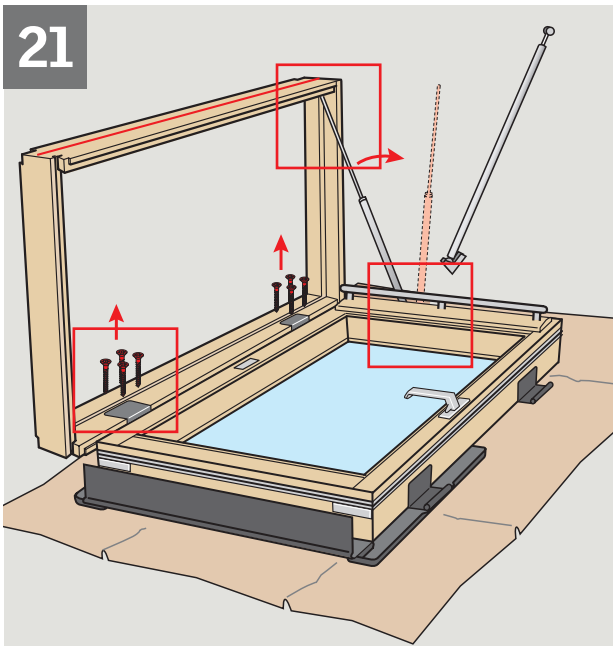

22

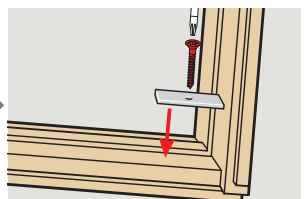
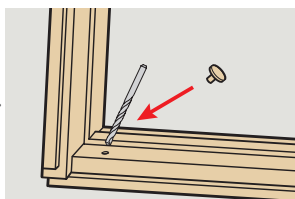
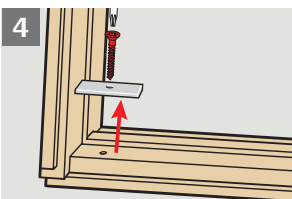
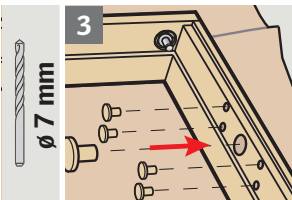
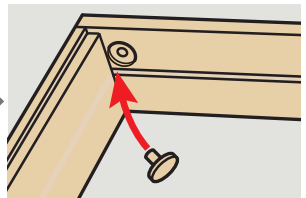
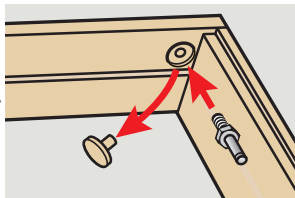
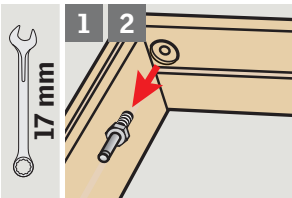
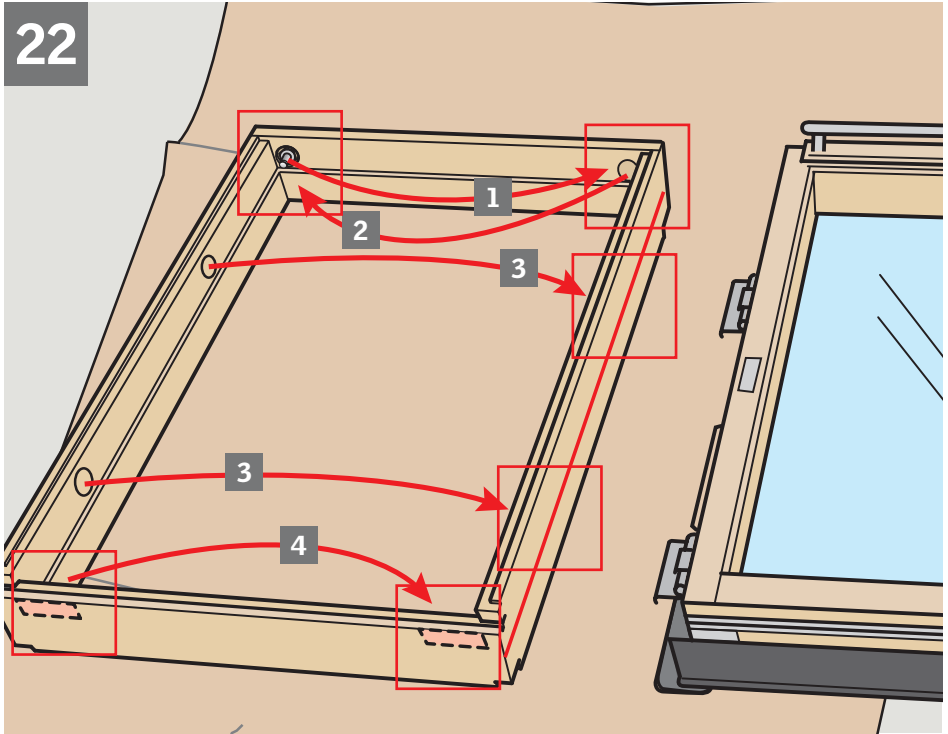

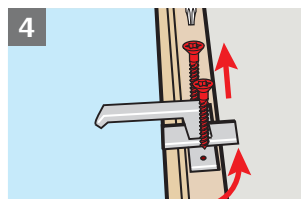
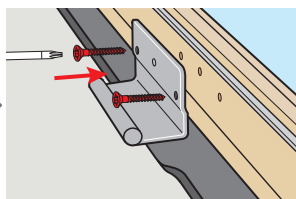
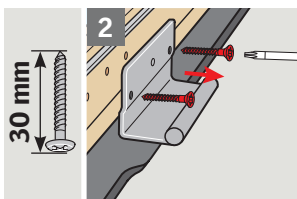
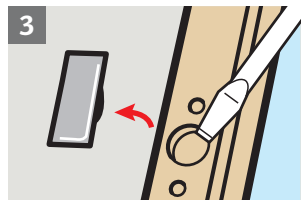
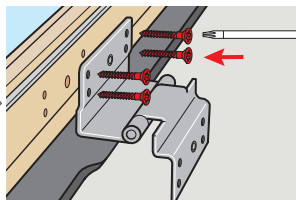
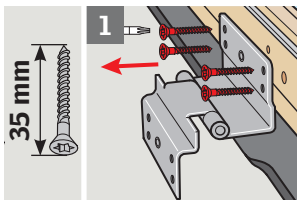
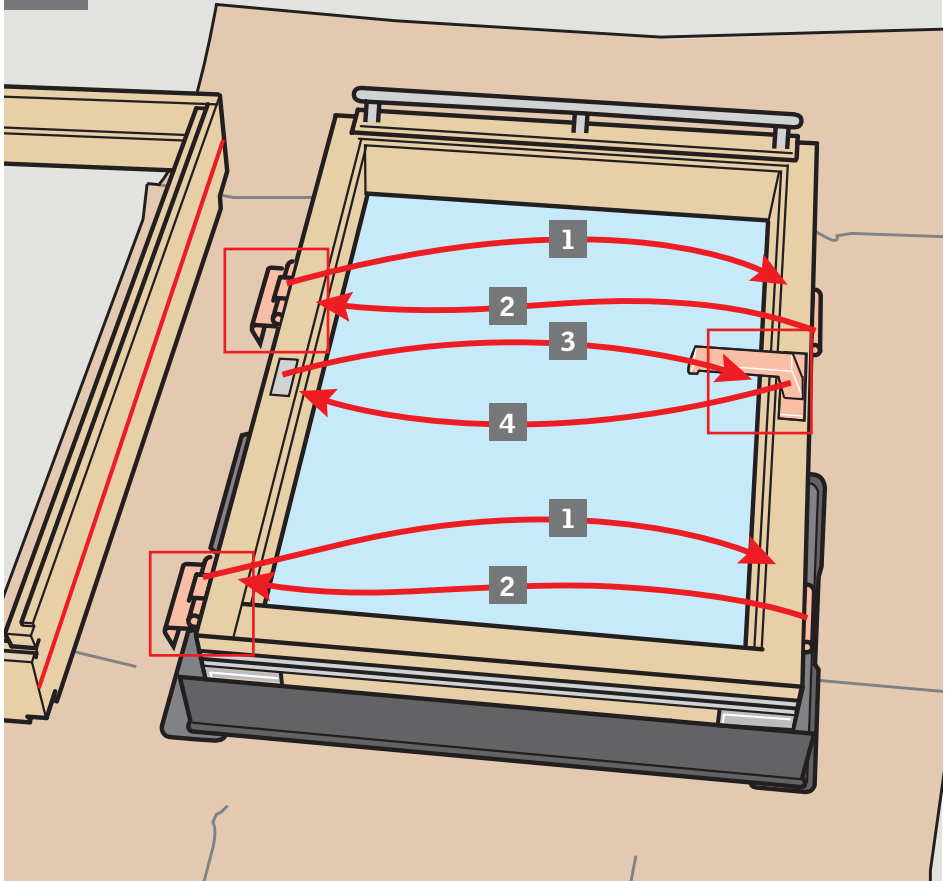

24

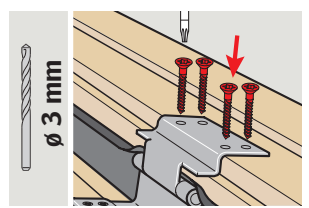
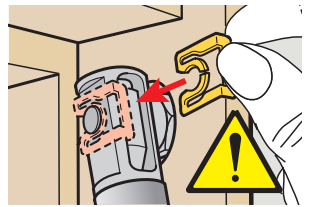
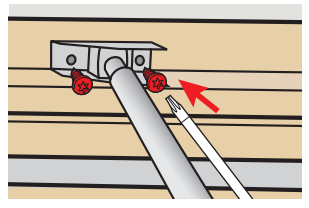
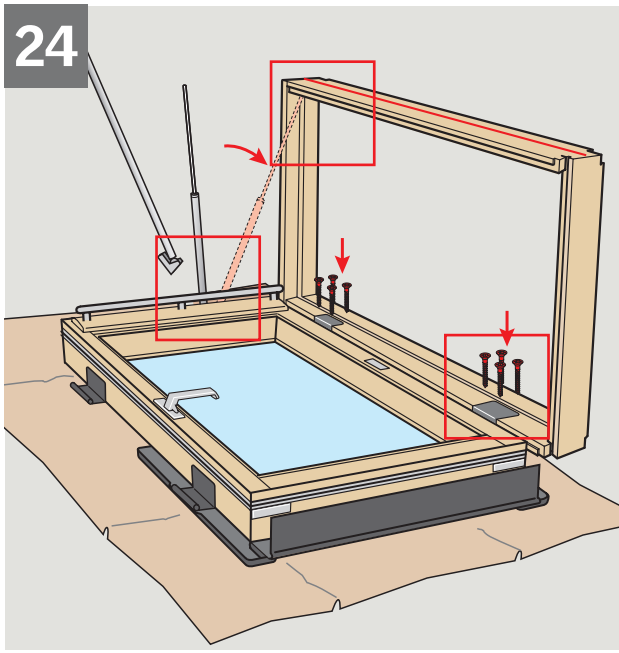

25

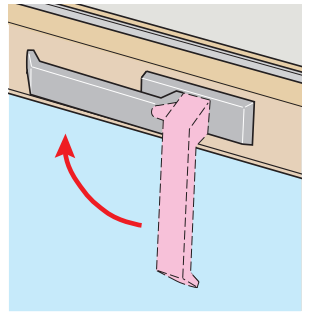
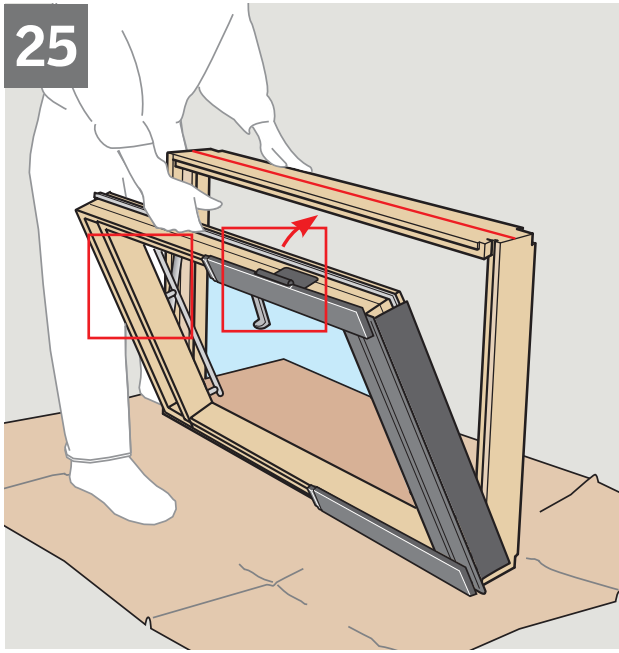

|   |  |
|---|--|
| <b>AR:</b> VELUX Argentina S.A.<br>3488 639944 / 45 / 46            | <b>IE:</b> VELUX Company Ltd.<br>01 848 8775                                     |
| <b>AT:</b> VELUX Österreich GmbH<br>02245/32 3 50                   | <b>IT:</b> VELUX Italia s.p.a.<br>045/6173666                                    |
| <b>AU:</b> VELUX Australia Pty. Ltd.<br>1300 859 856                | <b>JP:</b> VELUX-Japan Ltd.<br>0570-00-8145                                      |
| <b>BA:</b> VELUX Bosna i Hercegovina d.o.o.<br>033/626 493, 626 494 | <b>LT:</b> VELUX Lietuva, UAB<br>(85) 270 91 01                                  |
| <b>BE:</b> VELUX Belgium<br>(010) 42.09.09                          | <b>LV:</b> VELUX Latvia SIA<br>67 27 77 33                                       |
| <b>BG:</b> VELUX Bulgaria EOOD<br>02/955 95 26                      | <b>NL:</b> VELUX Nederland B.V.<br>030 - 6 629 629                               |
| <b>BY:</b> VELUX Roof Windows FE.<br>(017) 217 7385                 | <b>NO:</b> VELUX Norge AS<br>22 51 06 00   |
| <b>CA:</b> VELUX Canada Inc.<br>1 800 88-VELUX (888-3589)           | <b>NZ:</b> VELUX New Zealand Ltd.<br>0800 650 445                                |
| <b>CH:</b> VELUX Schweiz AG<br>0848 945 549                         | <b>PL:</b> VELUX Polska Sp. z o.o.<br>(022) 33 77 000 / 33 77 070                |
| <b>CL:</b> VELUX Chile Limitada<br>2 953 6789                       | <b>PT:</b> VELUX Portugal, Lda<br>21 880 00 60                                   |
| <b>CN:</b> VELUX (CHINA) CO. LTD.<br>0316-607 27 27                 | <b>RO:</b> VELUX România S.R.L.<br>0-8008-83589                                  |
| <b>CZ:</b> VELUX Česká republika, s.r.o.<br>531 015 511             | <b>RS:</b> VELUX Srbija d.o.o.<br>011 20 57 500                                  |
| <b>DE:</b> VELUX Deutschland GmbH<br>0180-333 33 99                 | <b>RU:</b> ZAO VELUX<br>(495) 737 75 20  |
| <b>DK:</b> VELUX Danmark A/S<br>45 16 45 16                         | <b>SE:</b> VELUX Svenska AB<br>042/20 83 80                                      |
| <b>EE:</b> VELUX Eesti OÜ<br>621 7790                               | <b>SI:</b> VELUX Slovenija d.o.o.<br>01 724 68 68                                |
| <b>ES:</b> VELUX Spain, S.A.<br>91 509 71 00                        | <b>SK:</b> VELUX Slovensko, s.r.o.<br>(02) 33 000 555                            |
| <b>FI:</b> VELUX Suomi Oy<br>0207 290 800                           | <b>TR:</b> VELUX Çatı Pencereleeri<br>Ticaret Limited Şirketi<br>0 216 302 54 10 |
| <b>FR:</b> VELUX France<br>0821 02 15 15<br>0,119€ TTC/min          | <b>UA:</b> VELUX Ukraina TOV<br>(044) 2916070                                    |
| <b>GB:</b> VELUX Company Ltd.<br>01592 778 225                      | <b>US:</b> VELUX America Inc.<br>1-800-88-VELUX                                  |
| <b>HR:</b> VELUX Hrvatska d.o.o..<br>01/5555 444                    |  |
| <b>HU:</b> VELUX Magyarország Kft.<br>(06/1) 436-0601               |  |