

VELUX®

GHL/GHU/GPL/GPU

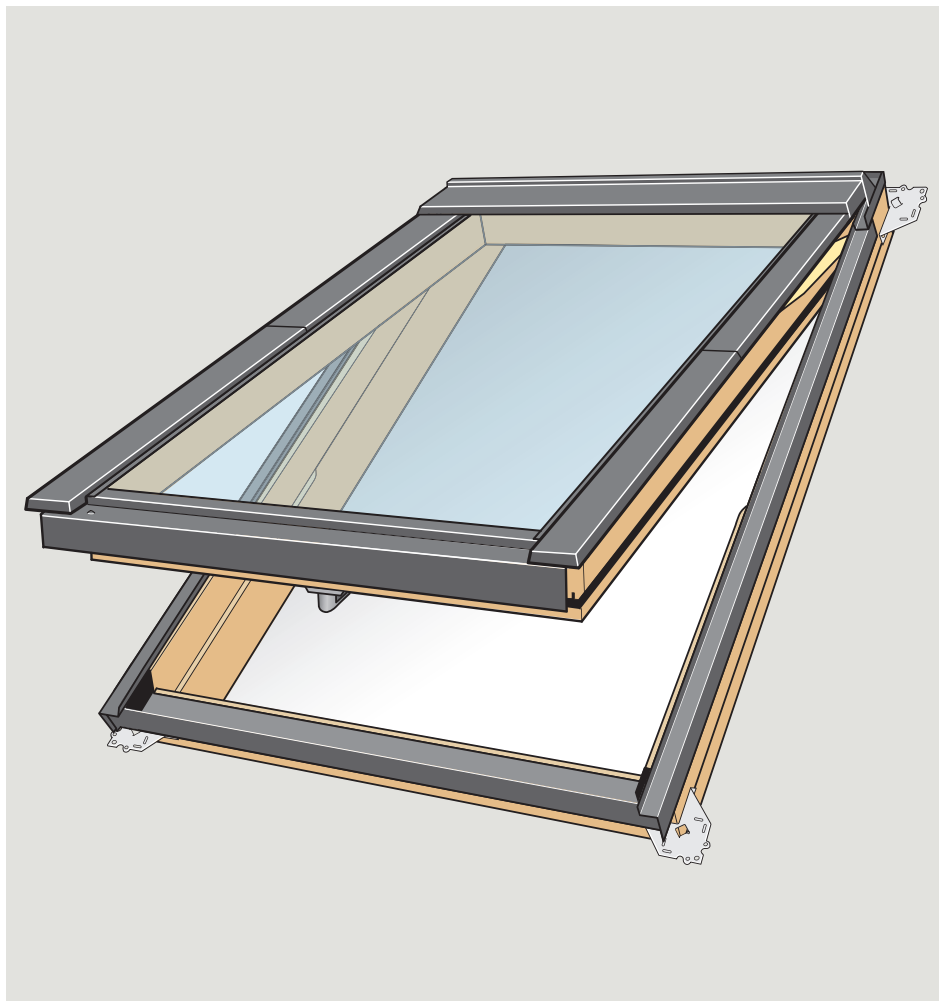

VAS 452226-2010-09

GHL/GHU/GPL/GPU



E--



BFX



BDX



BBX



LS-

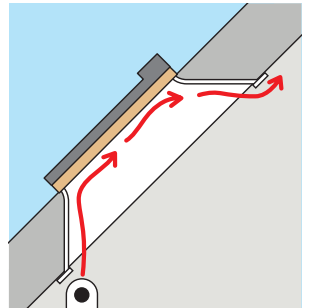
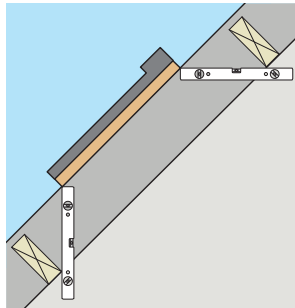
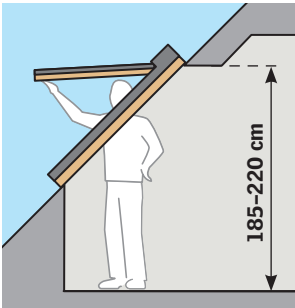
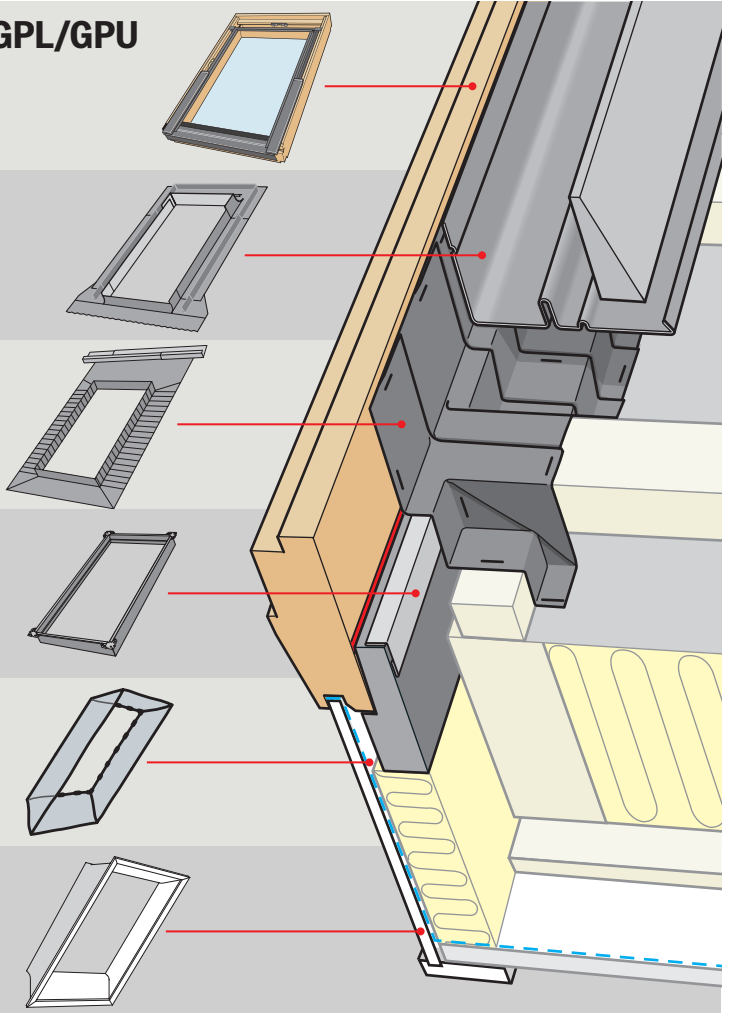

1

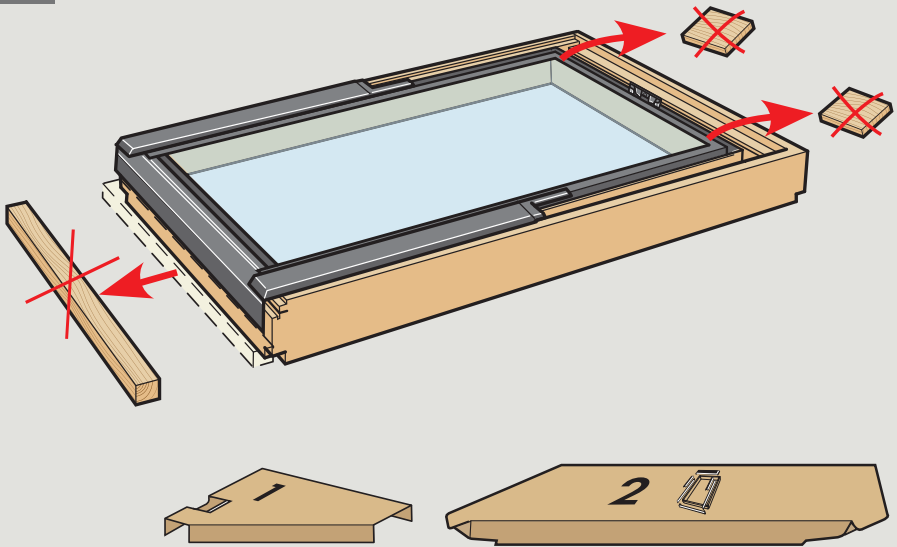

2

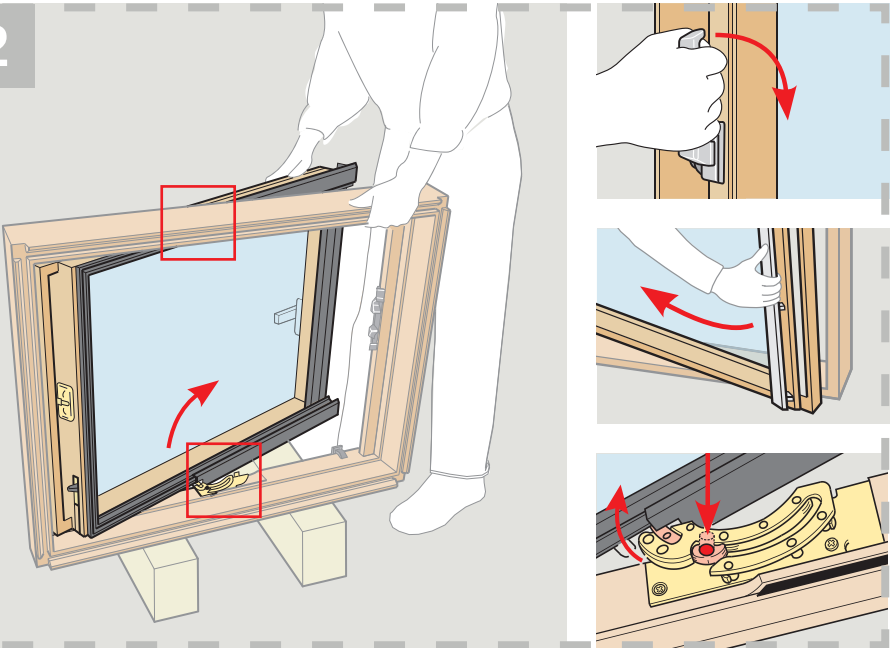



EDL
EDS
EDW
EDZ



EDB
EDE
EDJ
EDN
EDP
ELX
EL
EW

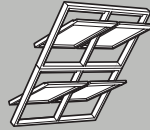

EB-
EK-



EF-
GI-
VF-

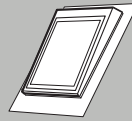

EA-
EU-

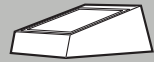

ECX



3

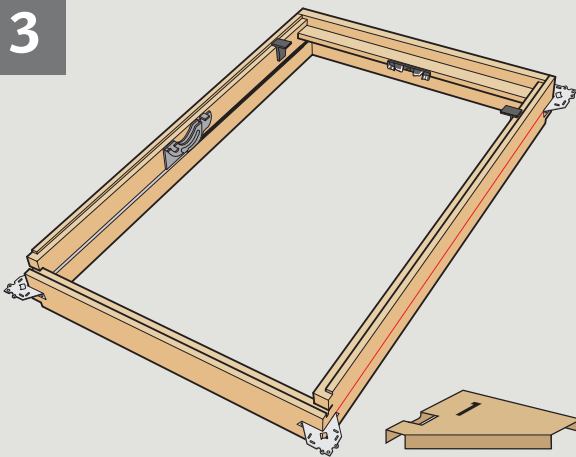

30 mm

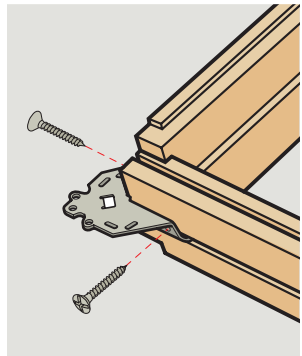

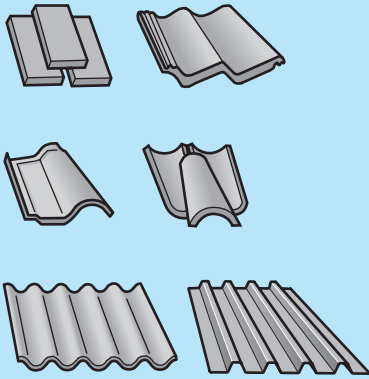

EDW/EDZ

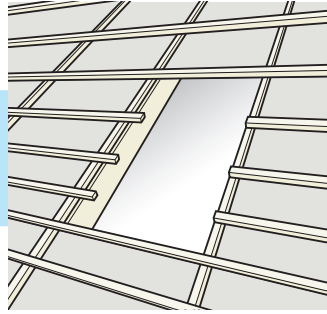

4a

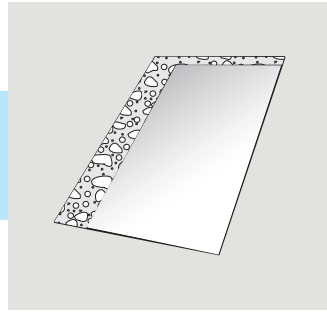

4b

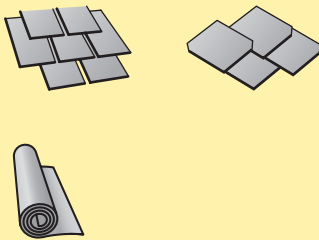

EDL/EDS

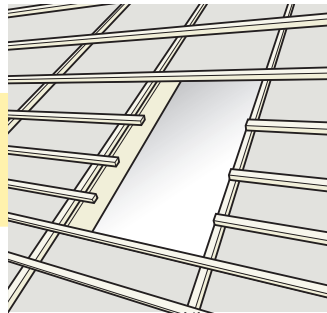

4c

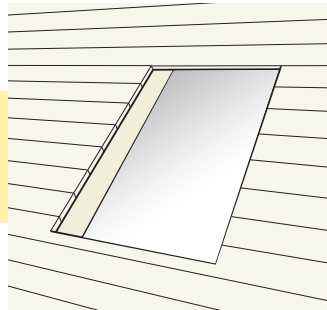

4d

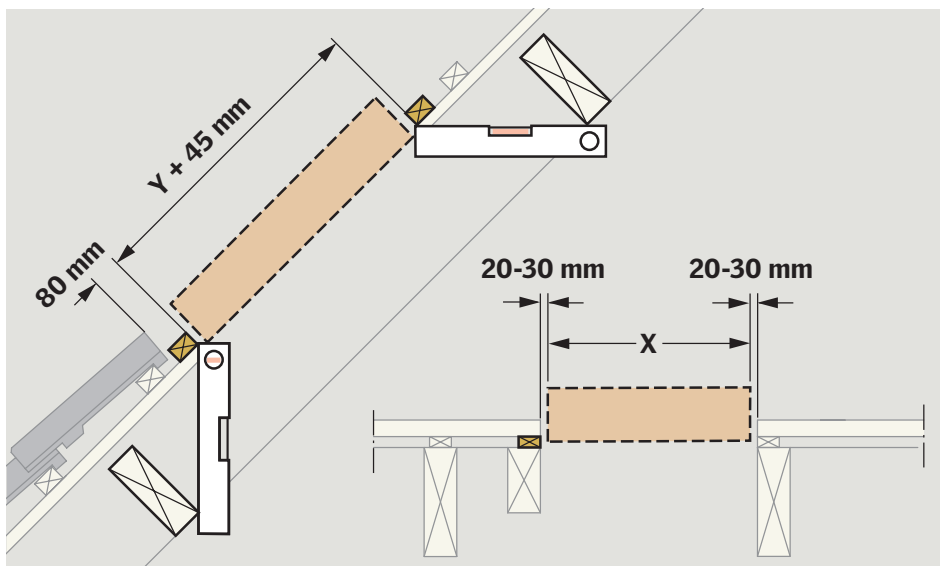
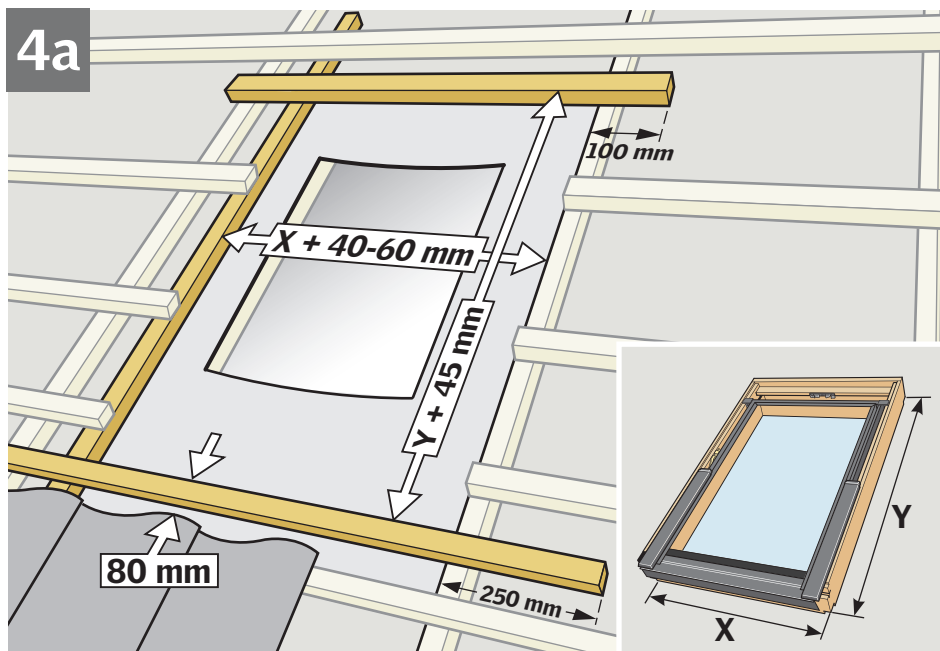
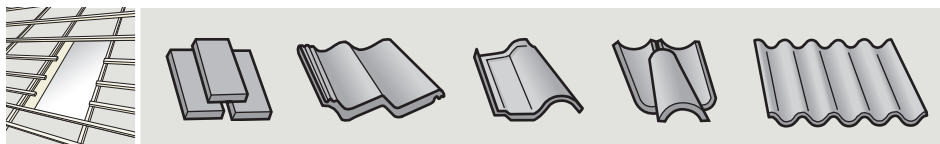

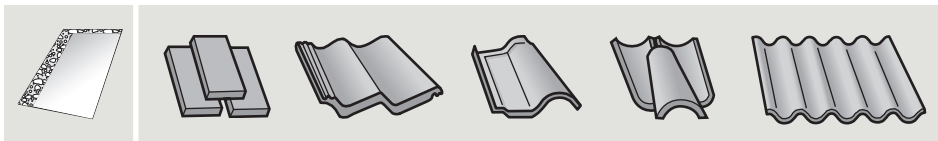

4b

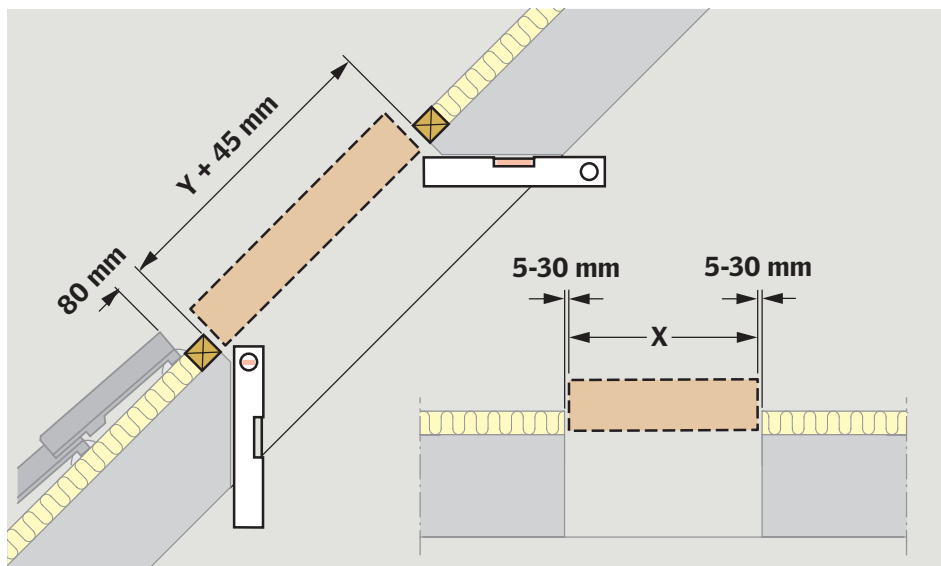
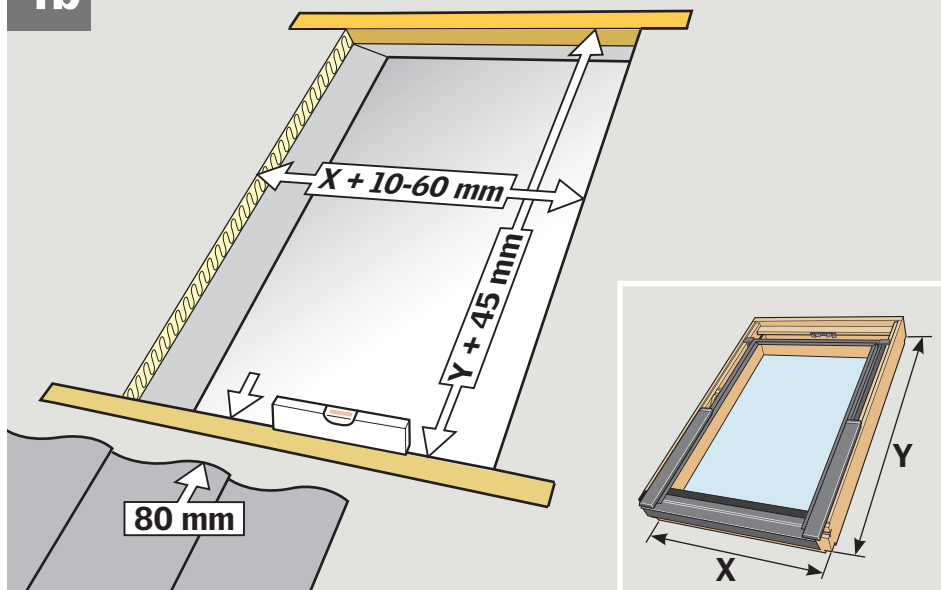

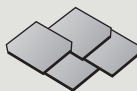
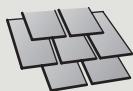
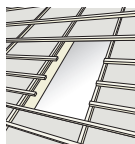

4c

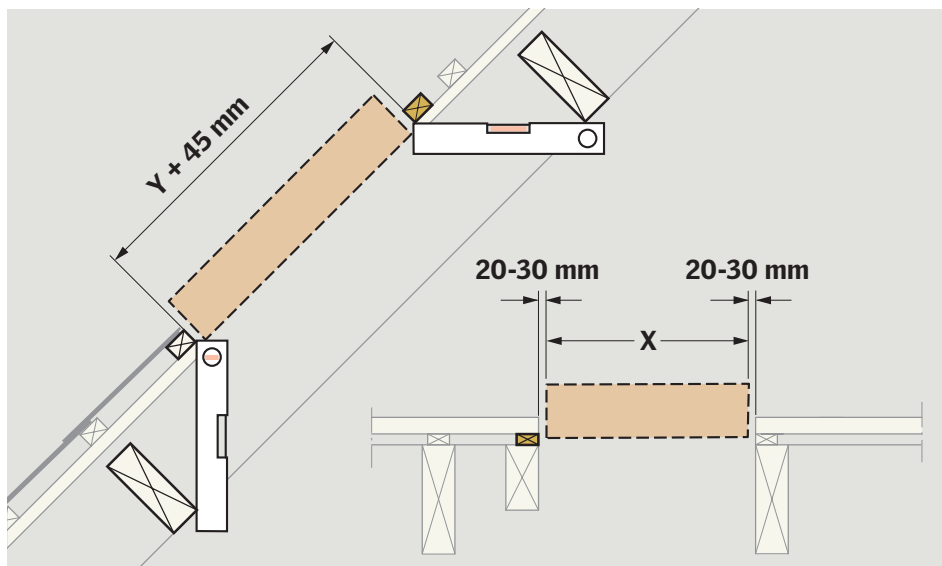
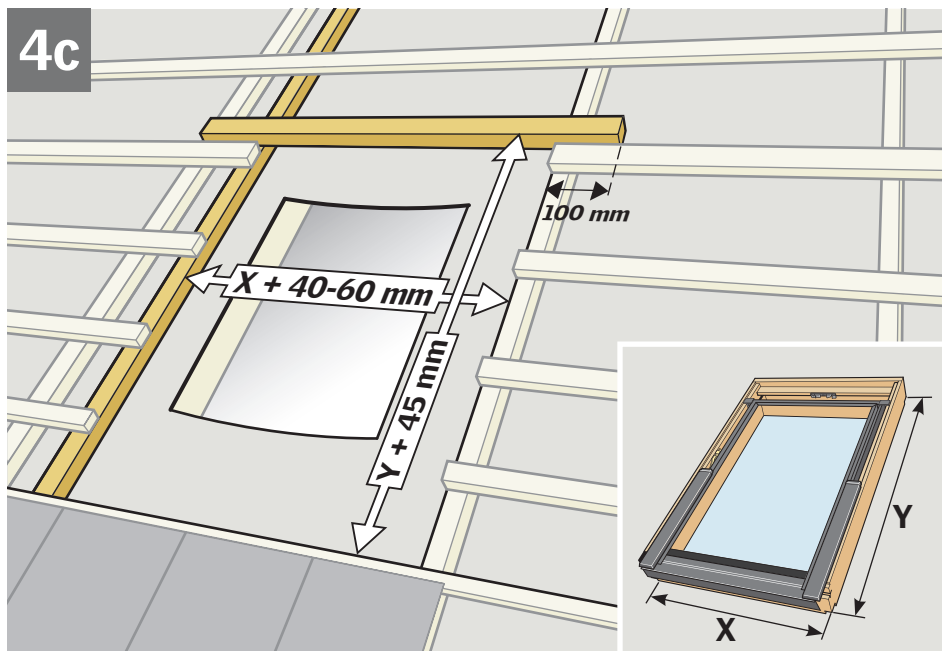

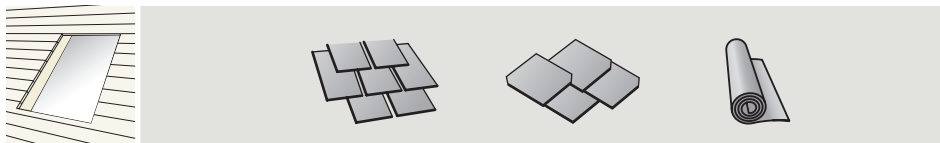

4d

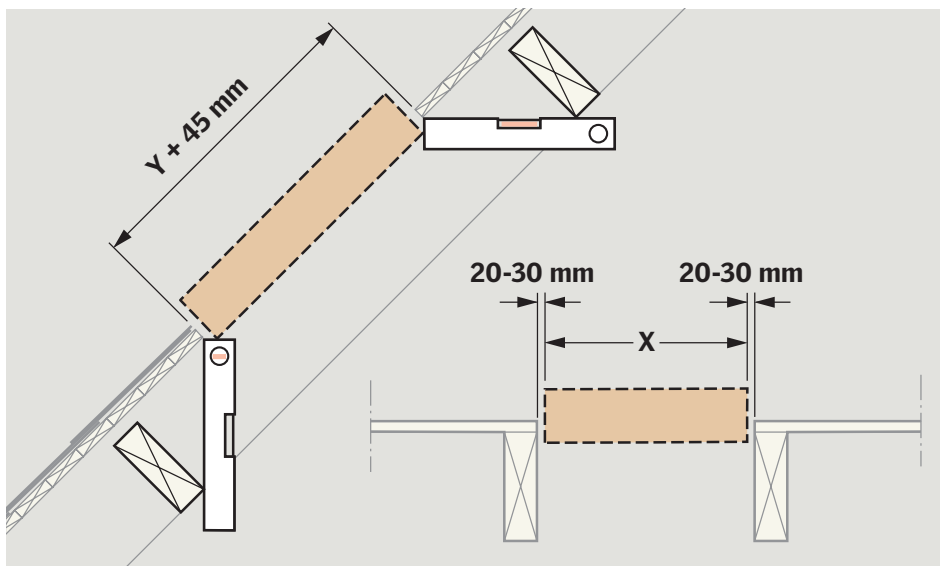
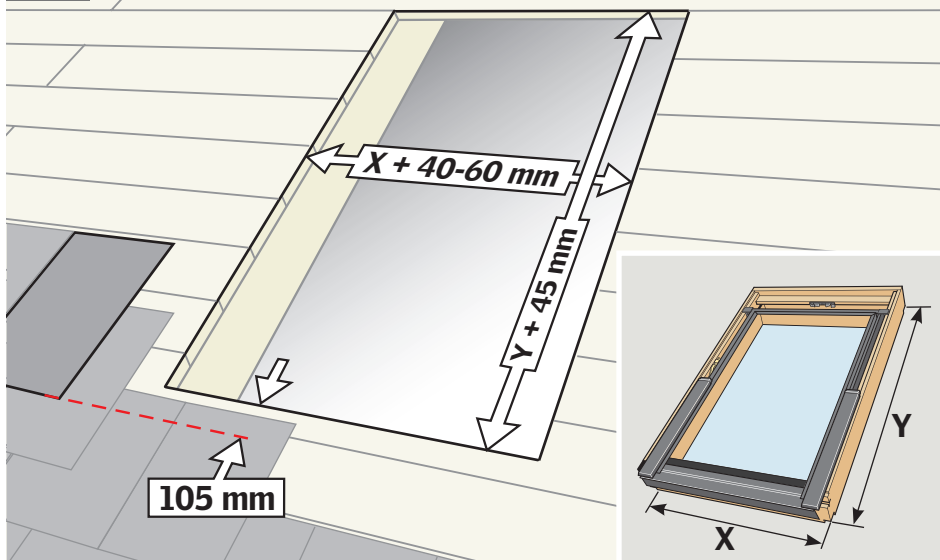

5

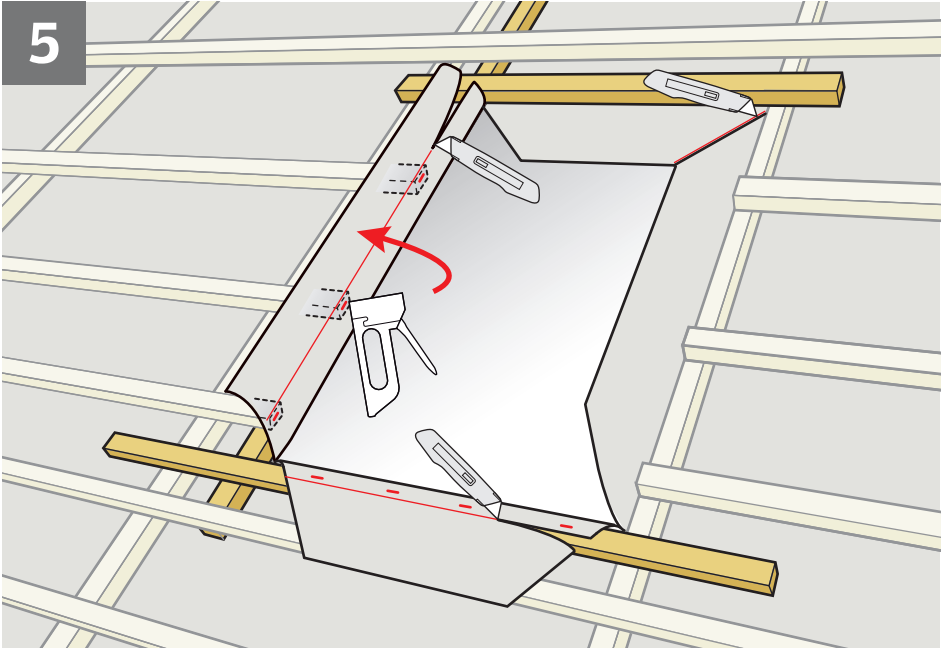

6

BDX

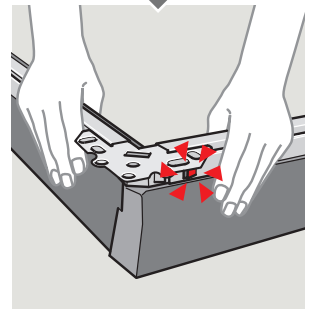
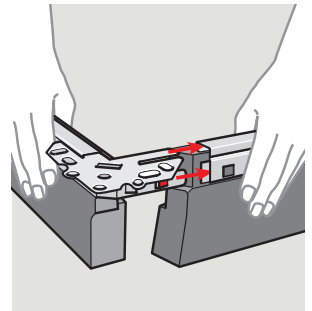
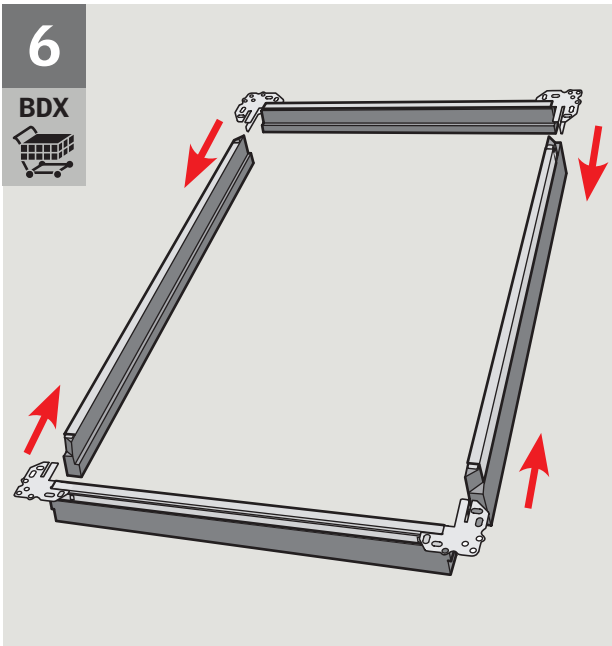

7

BDX

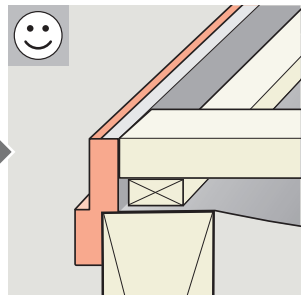
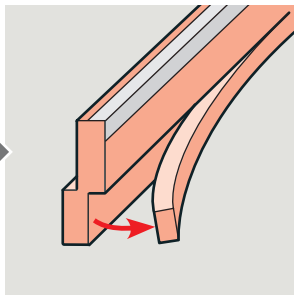
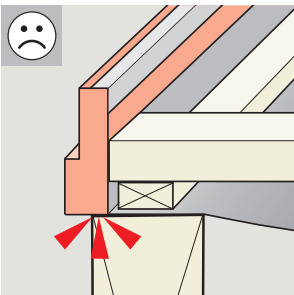
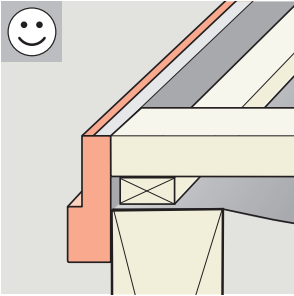
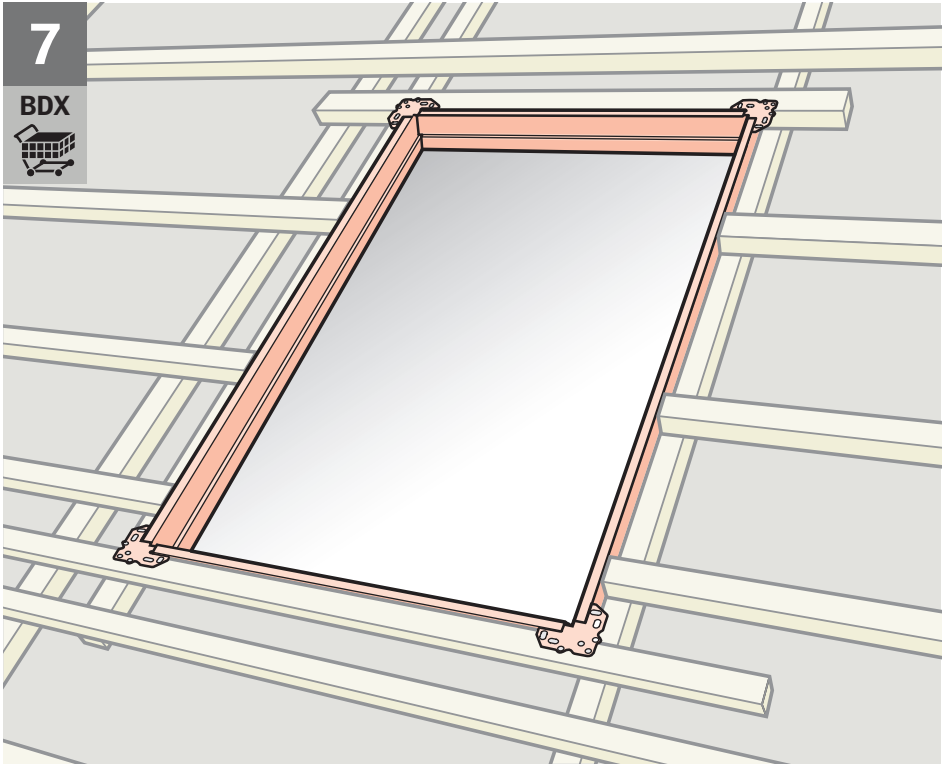

8

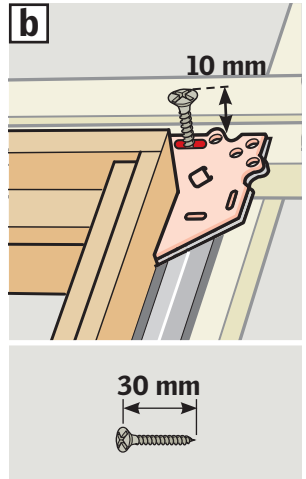
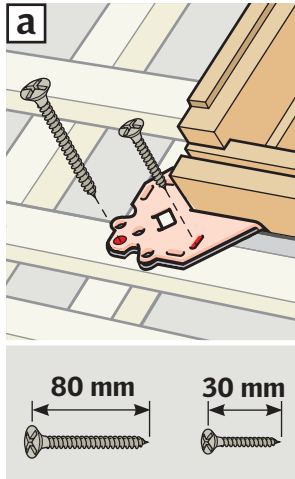
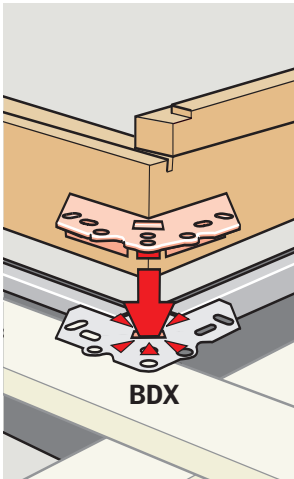
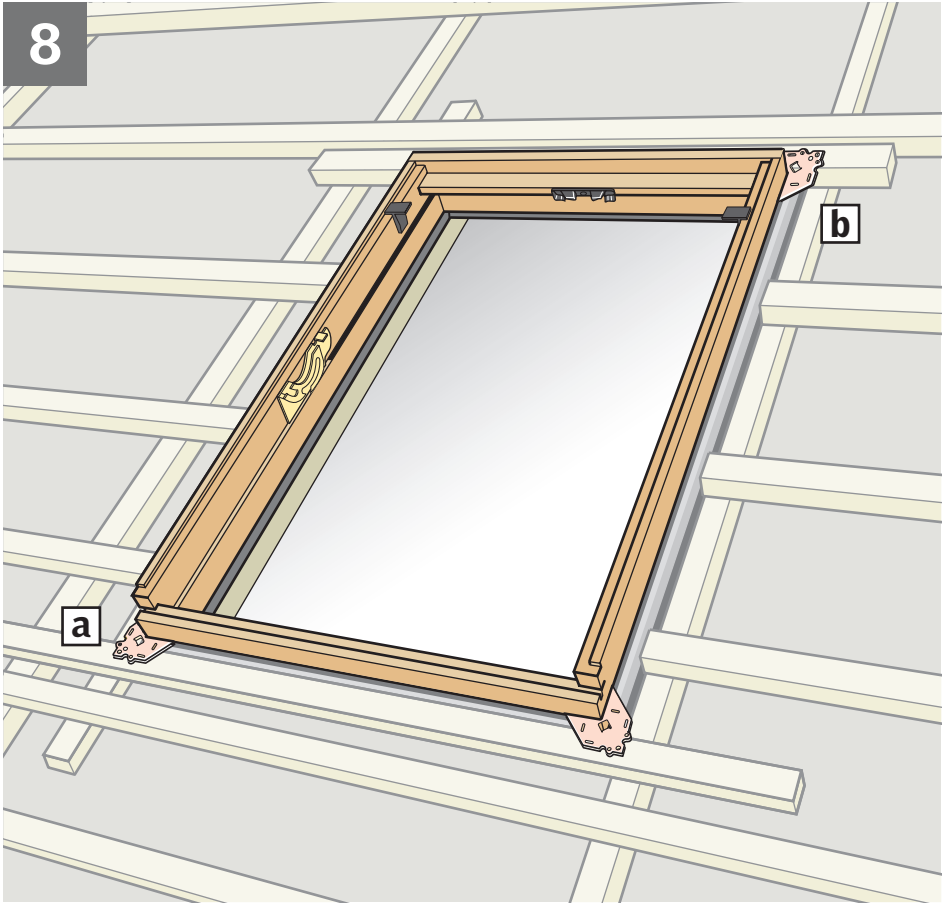

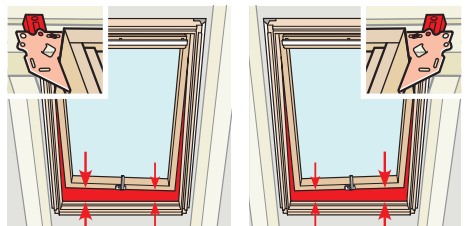
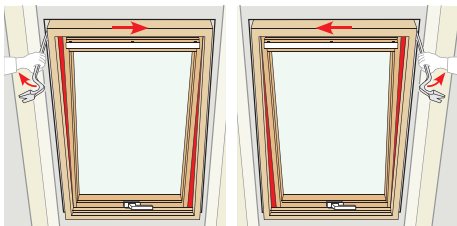
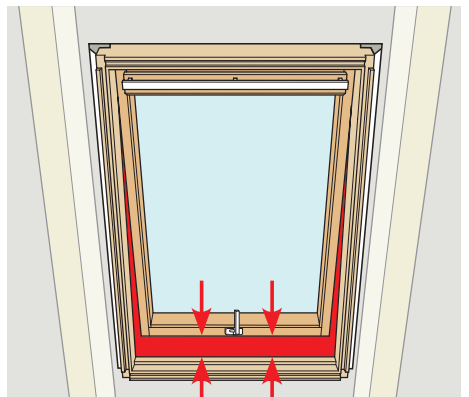
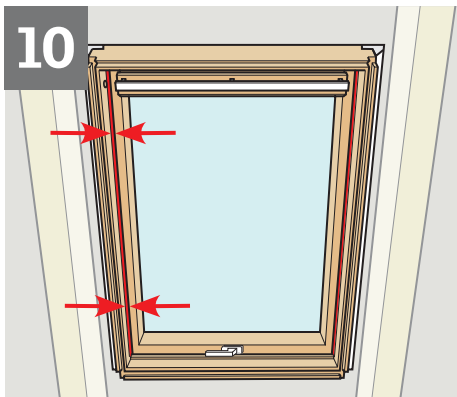
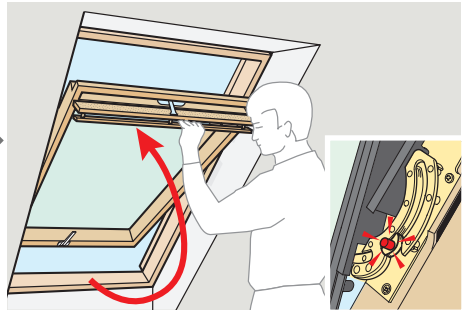
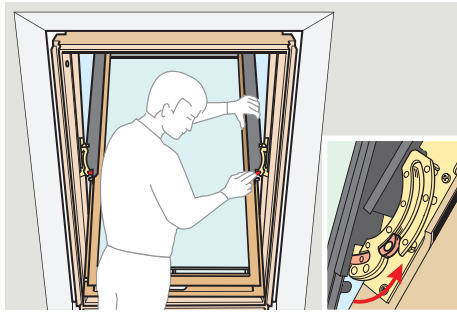
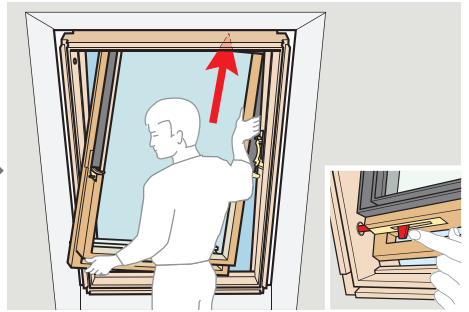
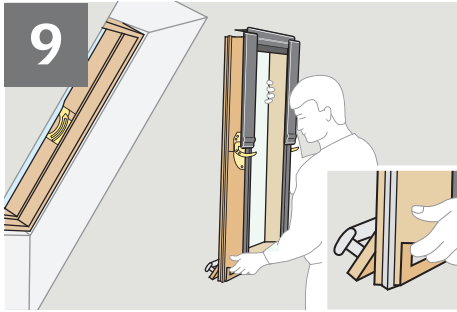

11

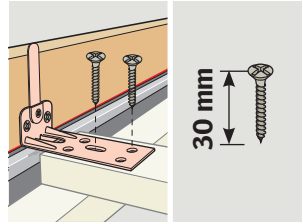
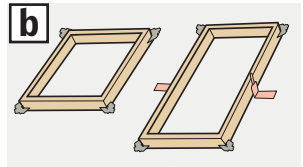
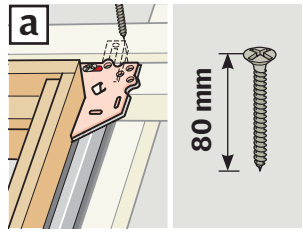
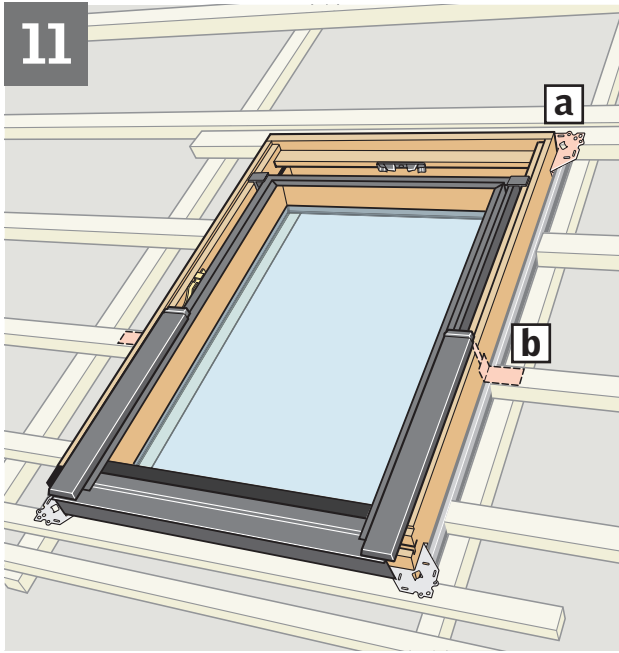

12

BDX

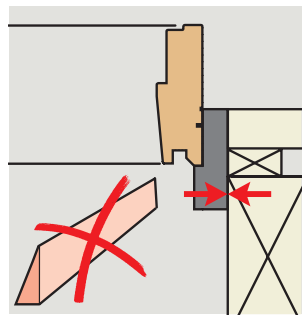
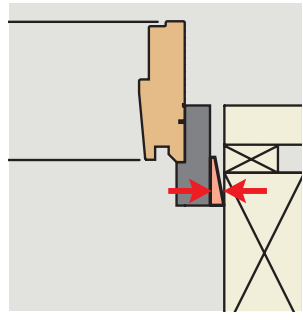
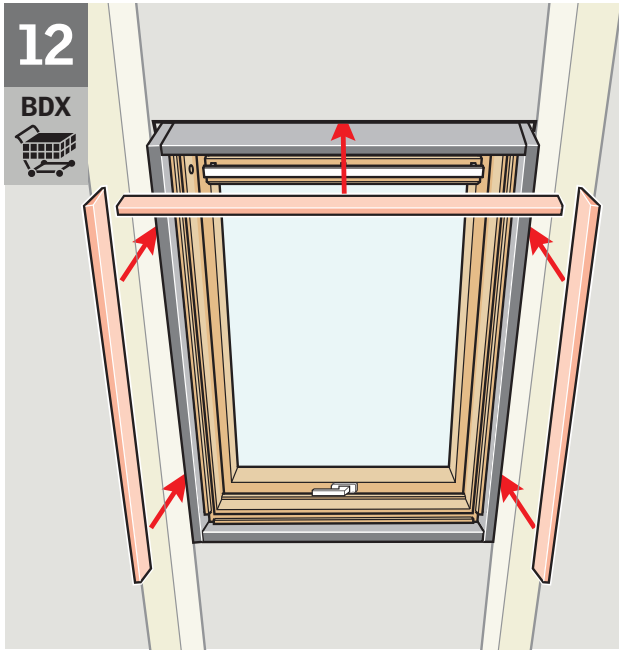
BFX

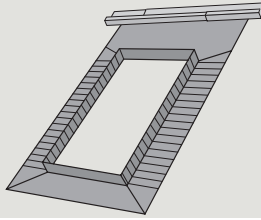

13

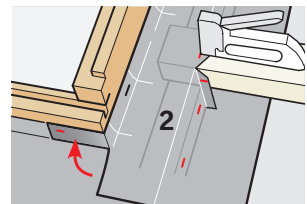
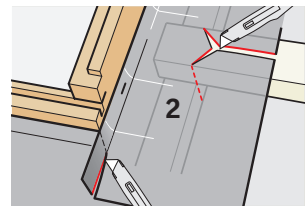
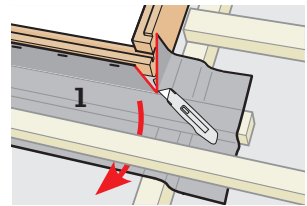
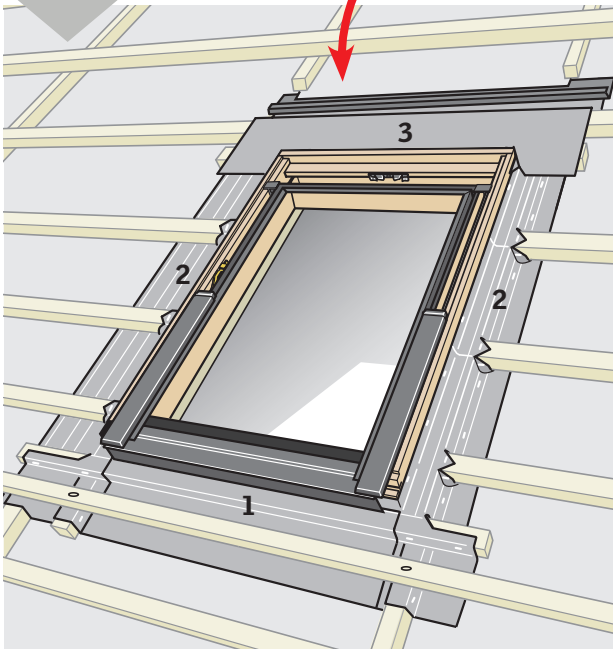
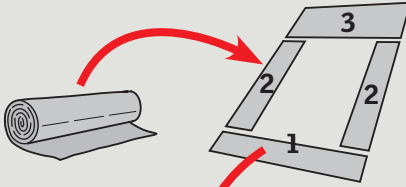

GHL

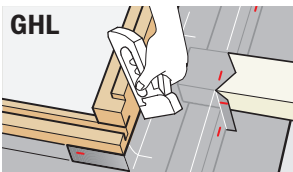

GPL
GPU
GHU

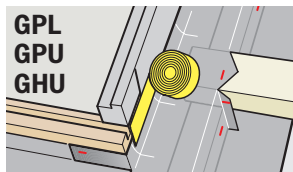

21

13

BFX

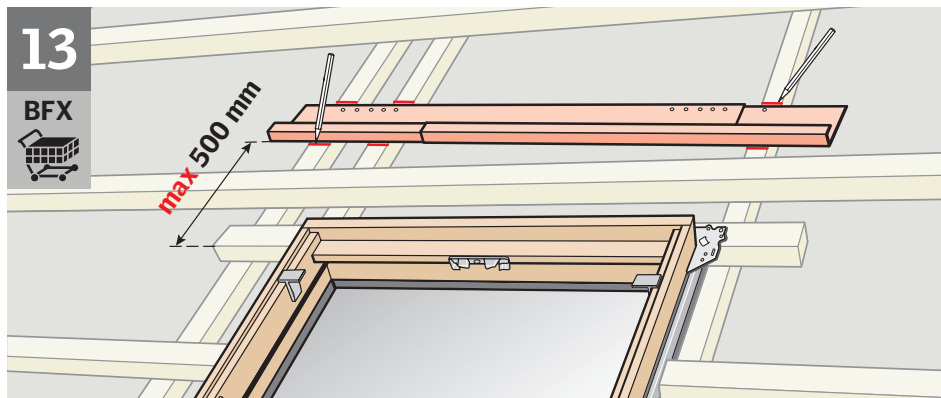

14

BFX

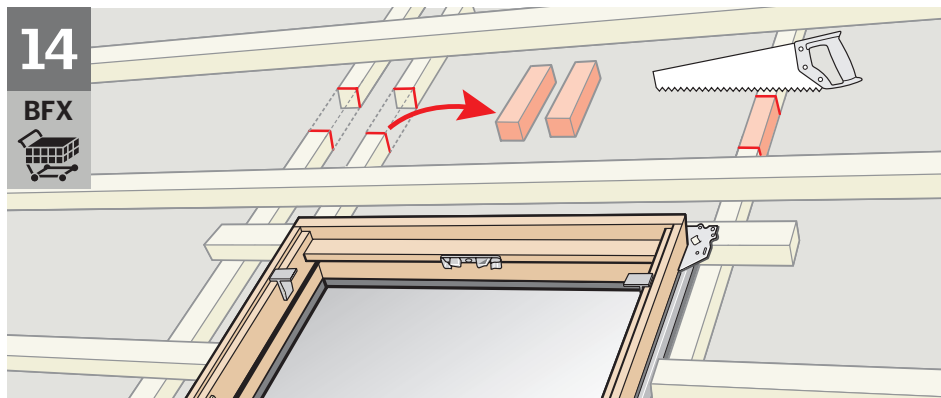

15

BFX

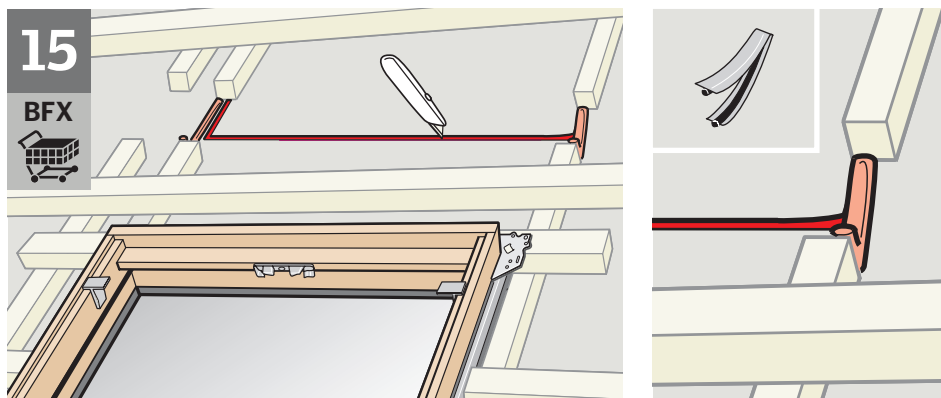

16

BFX

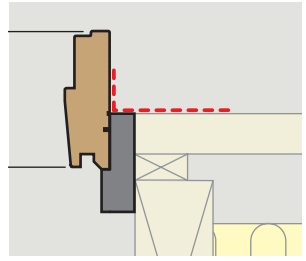
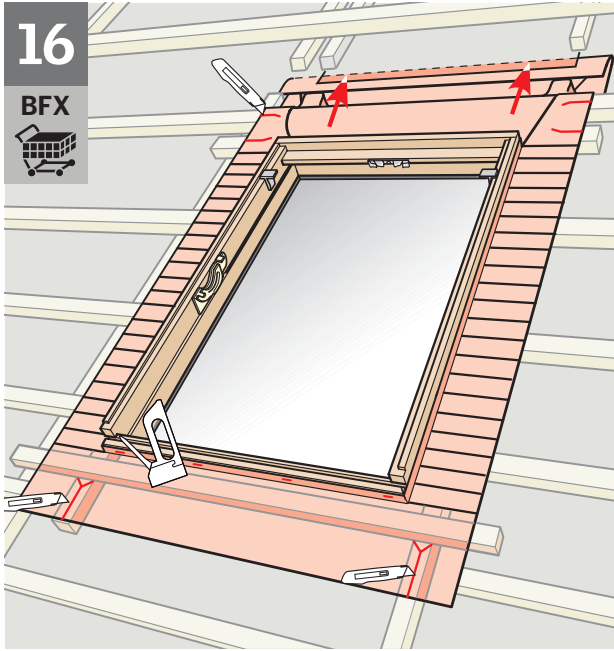

GHL

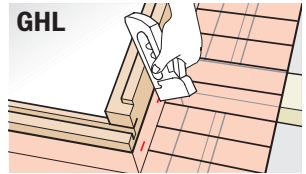

GPL
GPU
GHU

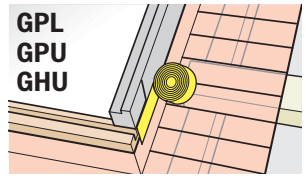

17

BFX

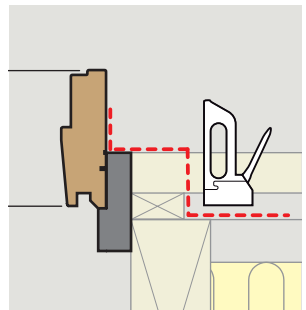
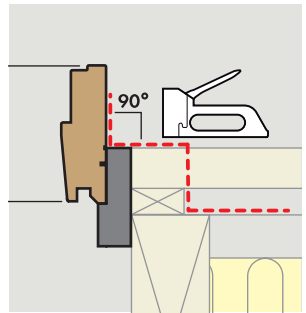
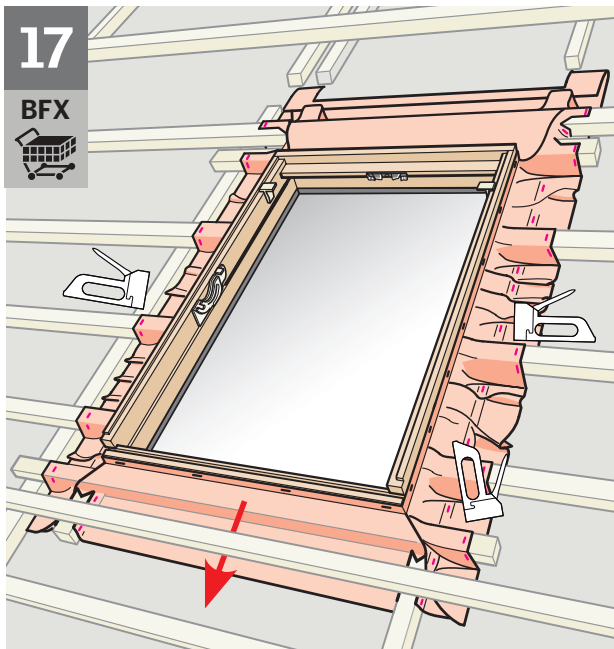

18

BFX

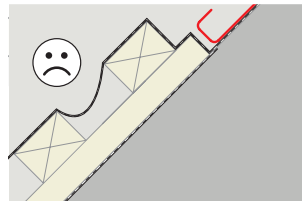
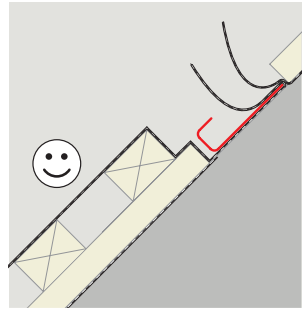
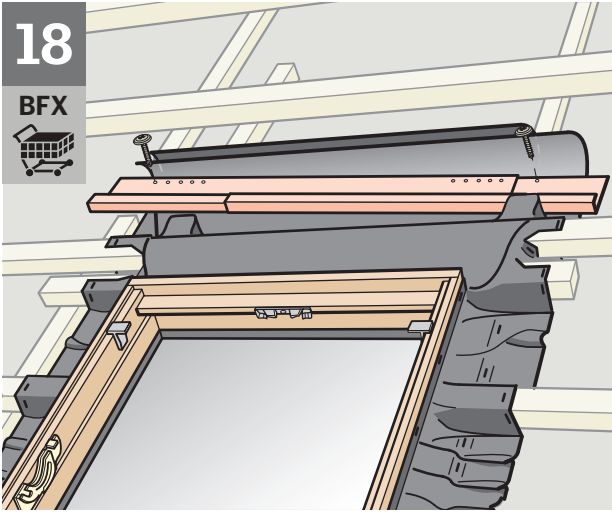

19

BFX

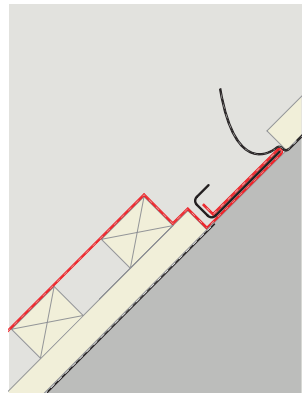
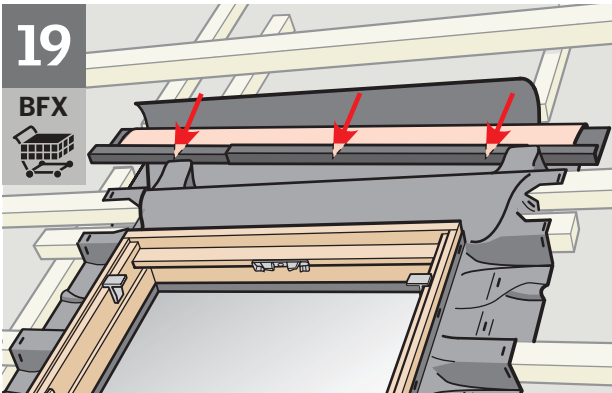

20

BFX

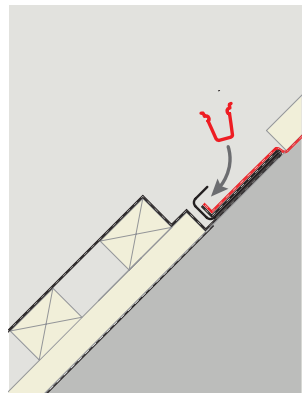
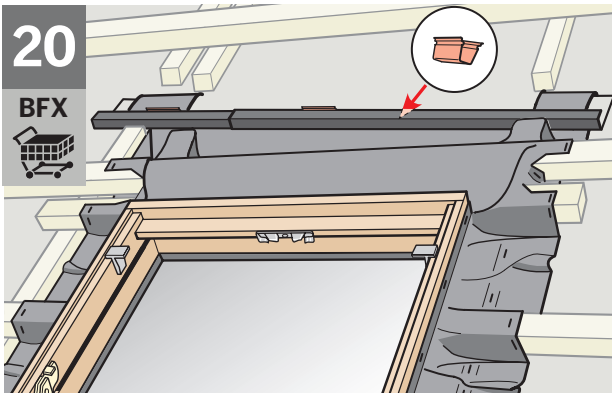

21

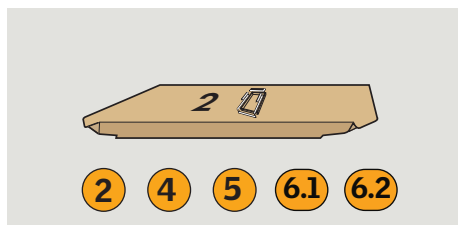
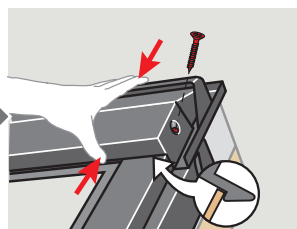
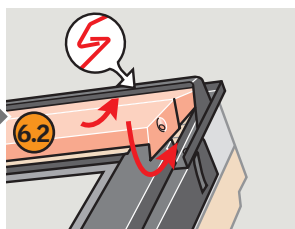
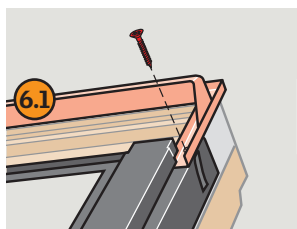
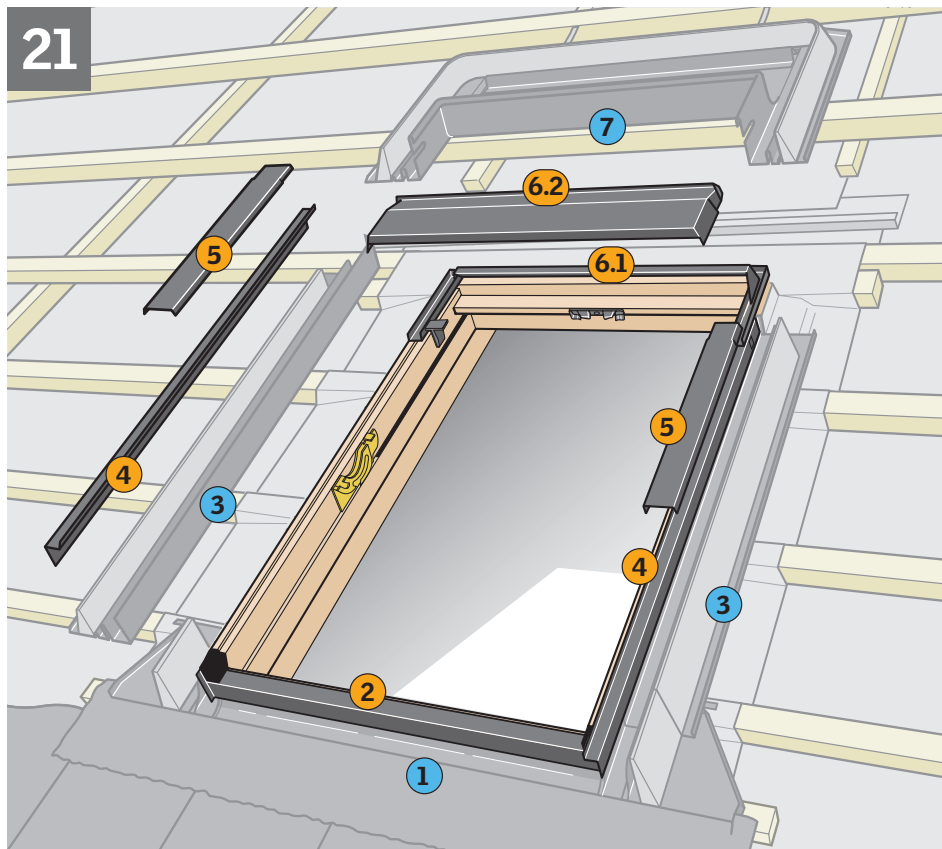

EDW
EDZ
EDL
EDS



22a GHU/GHU

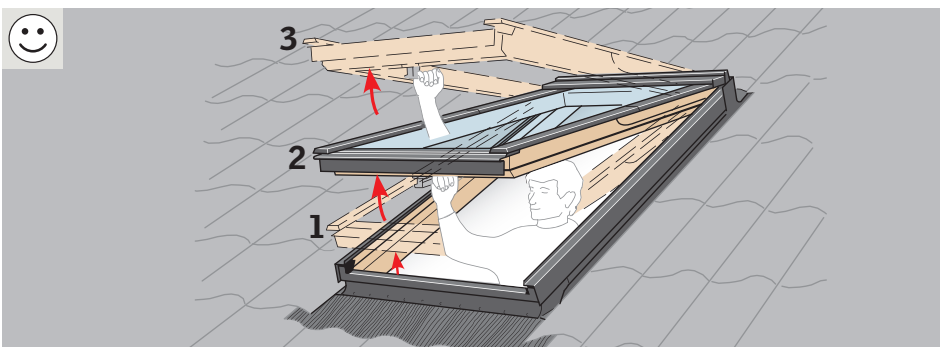
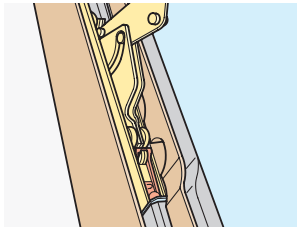
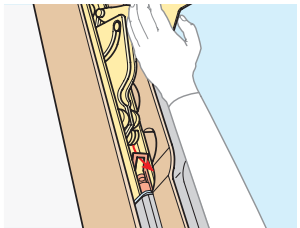
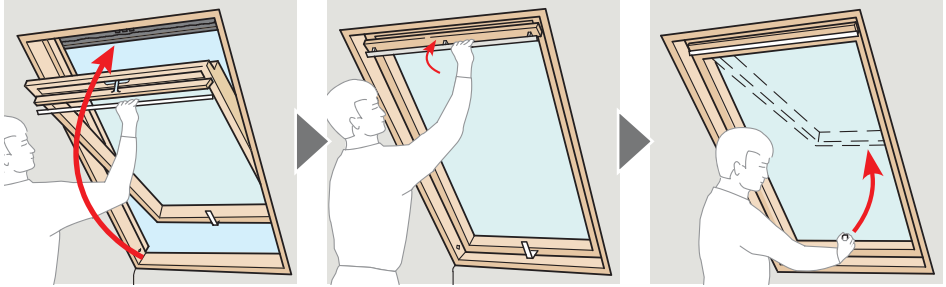

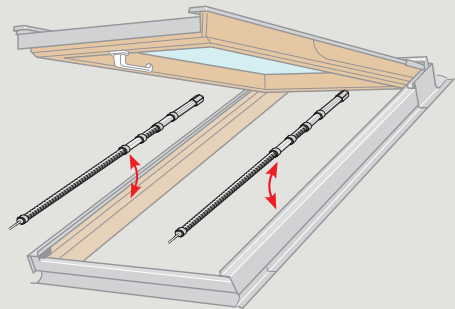
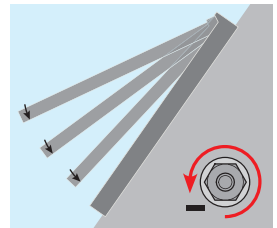
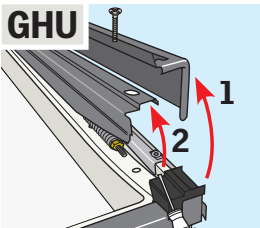
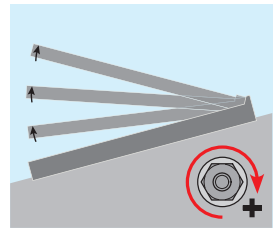
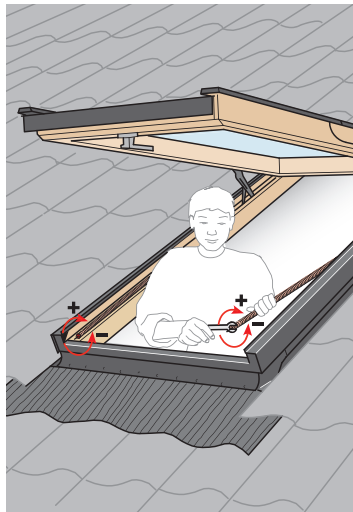
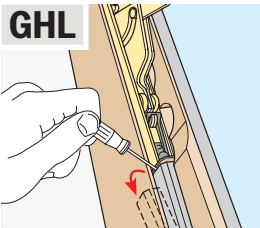
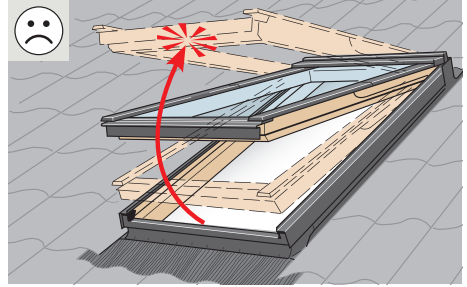
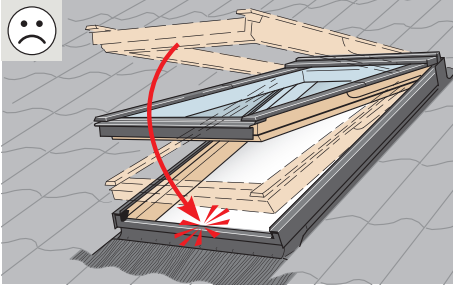

22b GPL/GPU

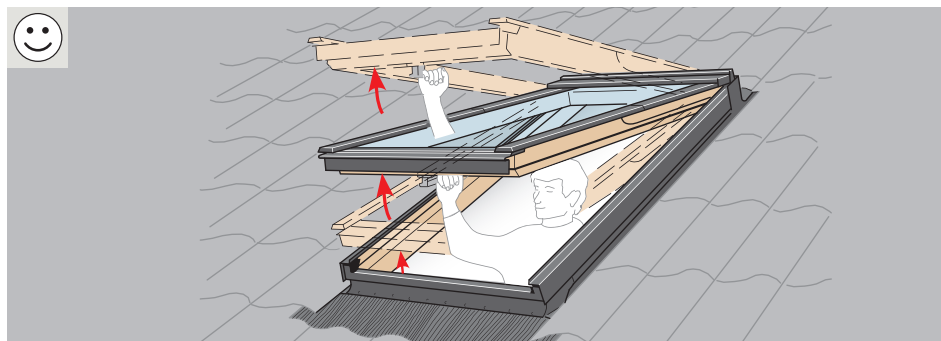
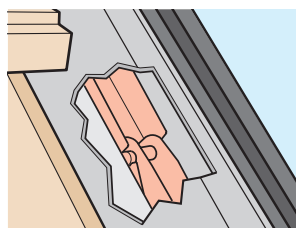
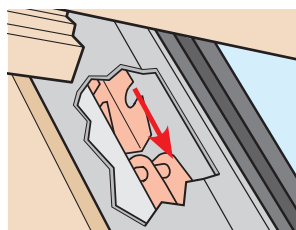
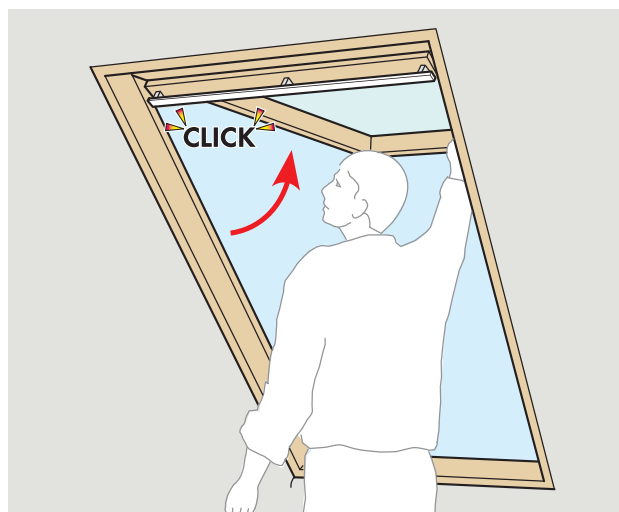
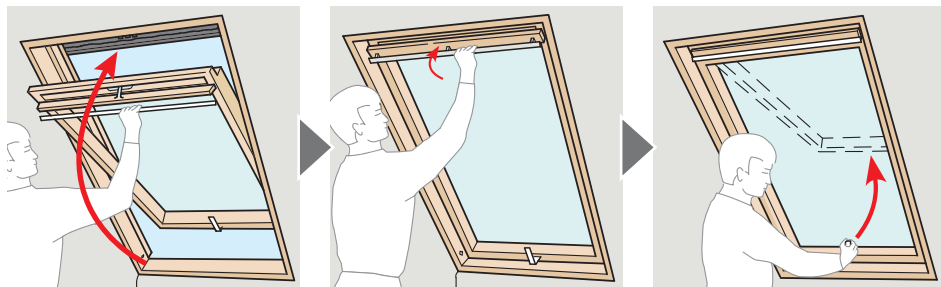

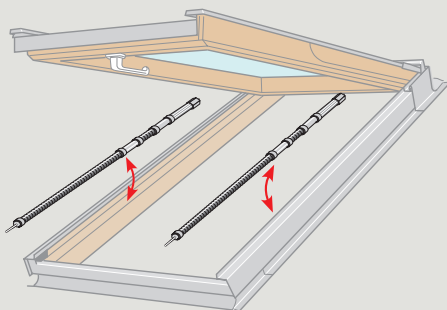
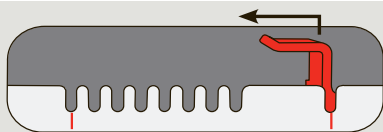
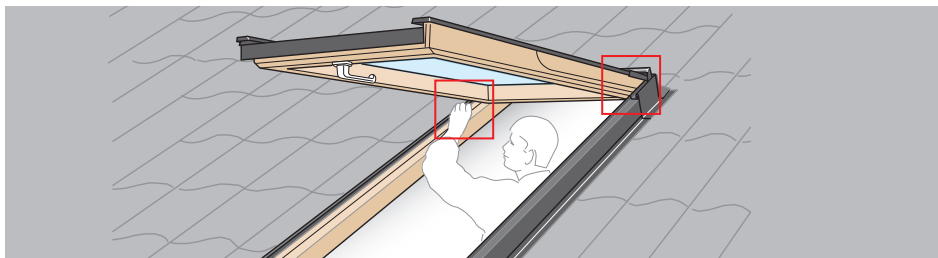
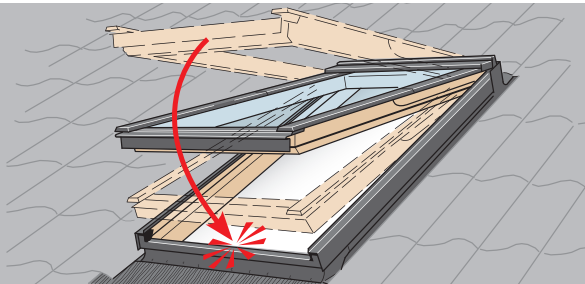

AR: VELUX Argentina S.A. 3488 639944 / 45 / 46	IE: VELUX Company Ltd. 01 848 8775
AT: VELUX Österreich GmbH 02245/32 3 50	IT: VELUX Italia s.p.a. 045/6173666
AU: VELUX Australia Pty. Ltd. 1300 859 856	JP: VELUX-Japan Ltd. 0570-00-8145
BA: VELUX Bosna i Hercegovina d.o.o. 033/626 493, 626 494	LT: VELUX Lietuva, UAB (85) 270 91 01
BE: VELUX Belgium (010) 42.09.09	LV: VELUX Latvia SIA 67 27 77 33
BG: VELUX Bulgaria EOOD 02/955 95 26	NL: VELUX Nederland B.V. 030 - 6 629 629
BY: VELUX Roof Windows FE. (017) 217 7385	NO: VELUX Norge AS 22 51 06 00
CA: VELUX Canada Inc. 1 800 88-VELUX (888-3589)	NZ: VELUX New Zealand Ltd. 0800 650 445
CH: VELUX Schweiz AG 0848 945 549	PL: VELUX Polska Sp. z o.o. (022) 33 77 000 / 33 77 070
CL: VELUX Chile Limitada 2 953 6789	PT: VELUX Portugal, Lda 21 880 00 60
CN: VELUX (CHINA) CO. LTD. 0316-607 27 27	RO: VELUX România S.R.L. 0-8008-83589
CZ: VELUX Česká republika, s.r.o. 531 015 511	RS: VELUX Srbija d.o.o. 011 20 57 500
DE: VELUX Deutschland GmbH 0180-333 33 99	RU: ZAO VELUX (495) 737 75 20
DK: VELUX Danmark A/S 45 16 45 16	SE: VELUX Svenska AB 042/20 83 80
EE: VELUX Eesti OÜ 621 7790	SI: VELUX Slovenija d.o.o. 01 724 68 68
ES: VELUX Spain, S.A. 91 509 71 00	SK: VELUX Slovensko, s.r.o. (02) 33 000 555
FI: VELUX Suomi Oy 0207 290 800	TR: VELUX Çatı Pencereleri Ticaret Limited Şirketi 0 216 302 54 10
FR: VELUX France 0821 02 15 15 0,119€ TTC/min	UA: VELUX Ukraina TOV (044) 2916070
GB: VELUX Company Ltd. 01592 778 225	US: VELUX America Inc. 1-800-88-VELUX
HR: VELUX Hrvatska d.o.o.. 01/5555 444	
HU: VELUX Magyarország Kft. (06/1) 436-0601	